

*HA File No. NJ2006.19-A*

***Northern Pine Snake Relocation and Management  
Plan, and Radio-tracking and Monitoring Plan  
for Stafford Business Park and Stafford Forge WMA***



*Submitted September 15, 2006*

*To*

**Mr. John Stokes, Executive Director  
*New Jersey Pinelands Commission***

*By*

**Robert T. Zappalorti, Executive Director/President  
*Herpetological Associates, Inc.*  
*Environmental Consultants*  
*Plant and Wildlife Specialists*  
575 Toms River Road Jackson, New Jersey 08527**

*and*

**Dave Golden, Senior Zoologist  
Division of Fish and Wildlife  
*Endangered and Nongame Species Program*  
New Jersey Department of Environmental Protection  
Trenton, New Jersey 08625**

❁ TABLE OF CONTENTS ❁

---

---

**Part I: Relocation and Management Plan**

**Introduction.** . . . . . 3  
    Background and Perspective. . . . . 4  
    Objectives of the Relocation and Management Plan. . . . . 4  
    Best Management Practices . . . . . 5  
    Remaining Tasks to Be Initiated. . . . . 6  
    Conceptual Pine Snake Relocation Plan. . . . . 7

**Habitat Description.** . . . . . 7  
    Soils. . . . . 7  
    Vegetative Communities. . . . . 8  
    Pitch Pine - Scrub Oak Forests . . . . . 8  
    Pitch Pine Lowlands. . . . . 8  
    Potential Prey. . . . . 8

**Materials and Methods.** . . . . . 9  
    Release Site Preparation and Clearing of Fields. . . . . 9  
    Guidelines for the Construction of a Wildlife Shelter/Snake Hibernaculum. . . . . 10  
    Experimental Treatments for Translocated Snakes. . . . . 11  
    Wild Adult Snakes Should be Released ASAP. . . . . 12  
    **Table One:** Planned Distribution of Pine Snakes to be Released at Dens. . . . . 14

**Discussion and Summary.** . . . . . 16

**Part II: Radio-Telemetry and Long-term Monitoring Plan**

**Introduction.** . . . . . 17

**Objectives of the Radio-telemetry and Long-term Monitoring Plan.** . . . . . 18

**Important Questions About Pine Snakes.** . . . . . 19

**Methods and Radio-tracking Procedures.** . . . . . 20  
    Monitoring Snakes at the Artificial Dens (2006 - 2007). . . . . 20  
    Experimental Research Design for Relocated Snakes. . . . . 21  
    Additional Radio-tracking of Non-relocated Snakes. . . . . 23

**Methods and Radio-tracking Procedures (Continued)**

Study Specimens. . . . . 23  
Sample Radio-tracking Data Sheet. . . . . 24  
Temporary Holding for Surgery.. . . . 26  
Habitat Use, Movements and Behavior. . . . . 26  
Procedures to Calculate Activity Range Parameters. . . . . 27  
Global Positioning System (GPS). . . . . 27  
Data Analysis. . . . . 28

**Funding, Budget, and Report Requirements. . . . . 28**

**Summary and Duration of Investigation. . . . . 29**

**Appendices - Cost of Seven-Year Investigation. . . . . 30**

Table 2.. . . . 31  
Table 3.. . . . 31  
Table 4.. . . . 32  
Table 5.. . . . 32  
Table 6.. . . . 33  
Table 7.. . . . 33  
Table 8.. . . . 34  
Table 9.. . . . 34  
Table 10.. . . . 35  
Table 11.. . . . 35  
Table 12.. . . . 36  
Table 13.. . . . 36  
Table 14.. . . . 37  
Table 15.. . . . 37

**Literature Cited, General References, and R. Zappalorti’s Publications. . . . . 38**

---

---





---

## PART I: RELOCATION AND MANAGEMENT PLAN

---

### INTRODUCTION

This study plan for the management, relocation, and subsequent monitoring of northern pine snakes (*Pituophis m. melanoleucus*), from the Stafford Business Park and Landfill is intended to partially fulfill the threatened and endangered species requirement of the “Memorandum of Agreement” (MOA), established between the Pinelands Commission, Ocean County, and Stafford Township on July 14, 2006. The MOA, which permits the redevelopment of the Stafford Business Park, stipulates that a northern pine snake management plan must be written and approved prior to beginning the redevelopment project. The Pinelands Commission (*hereafter* the Commission), in consultation with the New Jersey Department of Environmental Protection (*hereafter* the Department), is responsible for approving the final pine snake management and monitoring plan. Contained in this plan are the detailed actions that will be taken by the Commission and Department to avoid direct impacts to the pine snake population currently using the Stafford Business Park. In an effort to avoid direct mortality of individual pine snakes, roughly 102 snakes will be moved off the landfill site and relocated a short distance away (~ 3000 feet west), into Stafford Forge Wildlife Management Area. All relocation sites are within the documented activity range of this pine snake population. The Department’s, Division of Fish and Wildlife’s Endangered and Nongame Species Program (*hereafter* the Department) will have primary oversight on the implementation of this plan, whereas Herpetological Associates, Inc. (*hereafter* HA) will carry out the majority of the associated fieldwork and radio-tracking monitoring.

While there is limited research available on snake relocation, those studies that do exist suggest that it’s difficult to successfully relocate adult snakes (Dodd et al, 1991; Reinert et al, 1999; Reichling 2005; Himes et al, 2006). In their 1999 Pennsylvania study, Reinert and Rupert attributed the bulk of the translocated snake mortality they observed to an inability of some timber rattlesnakes to locate acceptable over-wintering sites, after being relocated. Our plan attempts to correct for the potential problem of snakes failing to find suitable dens by constructing artificial hibernacula at each of the release sites (Zappalorti et al 1994). Furthermore, this plan follows the recommendations given by Reinert and Rupert (1999) by not moving snakes outside their known activity range, as well as the recommendations of Dodd and Siegel (1991) by establishing a long-term monitoring program on the relocated snakes (described in Part II: Radio-Telemetry and Long-term Monitoring Plan).

## **BACKGROUND**

On July 31, 2006, a meeting was held at the Commission's office. This meeting was associated with the "Memorandum of Agreement" between Ocean County, Stafford Township and the Pinelands Commission, regarding the Stafford Business Park Redevelopment project. Present at the meeting were John Stokes, John Bunnell and Ken Carter from the Commission's staff. Dave Golden, from the Division of Fish and Wildlife, Endangered and Nongame Species Program, was there representing the NJDEP. Additionally, Joe DeDuca, Esquire and Michael Gross, Esquire, of Walter's Homes, Inc., were present along with their other consultant, Ken Paul from EcolSciences, Inc. Robert Zappalorti was included in to the meeting via telephone. Based upon the outcome of this meeting, HA and Dave Golden (the Department), were asked to prepare this Relocation and Management Plan - **Part I**, and a Radio-tracking and Monitoring Plan - **Part II**, for the northern pine snake (a state threatened species). These conservation plans are provided here in two parts, but under one cover. These combined plans and guidelines will be peer reviewed and considered by the Commission and the NJDEP.

EcolSciences, Inc. has been working on this project for the past three years (2004 to 2006). In June of 2006, HA was commissioned to collect gravid female pine snakes and/or their eggs. All field work and pine snake research was conducted at the Stafford Business Park (A.K.A. the Stafford Landfill Site) property. Gravid females found in the field were taken to HA's laboratory to deposit their eggs. Additionally, pine snake nest burrows found in the field at the Stafford Business Park were excavated and eggs were removed from the chambers.

HA knows of 9 clutches of eggs being laid in the field and/or laboratory. One of the radio-tracked females laid her eggs in a burrow, but a coyote ate the eggs before HA was able to excavate them. Therefore, HA collected 8 clutches of pine snake eggs from the Stafford Business Park property. This represents 80 eggs, of which six are thought to be infertile. Therefore, 74 eggs are currently incubating in the laboratory. It takes approximately 8 weeks for the pine snake eggs to incubate and hatch. The average clutch size is 9 eggs (range 4 to 14). There are 25 adults and one juvenile pine snake currently available for relocation to the Stafford Forge WMA.

Between 2004 and 2006, EcolSciences, Inc. and HA staff captured a total of 35 pine snakes, of which some gravid females were released without radio-transmitters in 2004 and 2005. A few hatchlings and juveniles which were too small for radio-transmitters and were also released. As a result, there are currently 16 adult pine snakes (fitted with radio-transmitters), roaming free in the wild at the Stafford Business Park. There are also 11 individual pine snakes without radio-transmitters being held in the laboratory, one of which is a juvenile and too small for radio-transmitter implantation. The other 9 adults were surgically implanted with radio-transmitters before the end of August, 2006.

## **MANAGEMENT PLAN TASKS AND OBJECTIVES**

Proposed relocation and management plan for the pine snakes includes the following major tasks:

1. Obtain all the necessary authorization from the New Jersey Department of Environmental Protection and the New Jersey Pinelands Commission.
2. In mid-August of 2006, select three specific sites within Stafford Forge Wildlife Management Area for pine snake management fields as the release sites.
3. The selected sites should have suitable soil and forest types. Then clear three management fields that measure 300 feet by 800 feet (~ 5.5-acres) in size.
4. Construct six (6) artificial snake dens, two at each management field (release site) within Stafford Forge Wildlife Management Area.
5. Around each artificial den, erect 4-foot high hardware cloth fences as holding corrals. These 0.15-acre holding area fences will encircle the dens and enclose both field and forested habitats. Additional fencing will be used to create 3-acre summer holding areas around 3 artificial dens.
6. The 78 pine snake eggs that were collected at the Stafford Business Park, will be incubated at HA's laboratory. All should hatch by September 18<sup>th</sup>.
7. Inject pit tags in all pine snakes (adults and hatchlings) as part of the long-term mark and recapture program.
8. Equal numbers of healthy pine snakes will be released within the 6 small winter fences at the 3 management fields on September 21, 2006. These snakes will be studied for 7-years (see the Radio-telemetry and Long-term Monitoring Plan on pages 19 through 32 ).
9. Refine and improve upon the methods of habitat management for "rare snakes."
10. The overall objective of the relocation and management plan is to avoid direct impacts to pine snakes by moving them off-site and replacing the nesting and denning habitat that will be lost as part of the SBP redevelopment project.





## **SITE DESCRIPTION**

### ***Stafford Business Park***

The Stafford Business Park and municipal landfill comprise a ~ 388-acre site located in Stafford Township, Ocean County, New Jersey. The site is located southwest of the junction of the Garden State Parkway and Route 72 (**Exit 63** of the Parkway). The activities permitted under the MOA allow for the capping of the Stafford municipal landfill as well as the construction of both residential and commercial development projects on the site.

### ***Stafford Forge Wildlife Management Area***

Stafford Forge is a 15,830-acre wildlife management area that is immediately adjacent to the Stafford Business Park. The Business Park is bounded by the WMA on its north, west, and south sides. The Stafford Forge WMA has been identified for experimental pine snake relocation effort. Two main factors make Stafford Forge WMA the obvious choice as a release site for the snakes that will be moved off Stafford Business Park: **1)** it is adjacent to the business park and includes portions of the snake's natural activity range, and **2)** most of its 15,830 acres consist of suitable habitat for pine snakes. What follows is a description of some of the habitat features of Stafford Forge WMA.

### ***Soils***

The soils of the areas where the relocations are planned are generally within the upland sand ridge habitat which is underlain with sandy substrate. The typical sandy soils selected by pine snakes in Ocean County are comprised of the following types:

***Lakewood Soil:*** Nearly level to steep, deep sand, well drained, soft, substrate. May have a depth of 40 inches or more.

***Lakehurst Soil:*** Nearly level to strongly sloping, well drained with a depth of 40 inches or more.

***Woodmansie Soil:*** Nearly level, to gently sloping, somewhat poorly drained or moderately well drained, some sand throughout, loamy soil at about 40 inches. Surrounding wetland sponges and pitch pine lowlands. Woodmansie soil is the dominant sand type at Stafford Forge WMA and is the soil present where the management fields will be cleared.



## **VEGETATIVE COMMUNITIES**

The forests within the Stafford Forge WMA are characteristic of pitch pine and scrub oak dominated habitat, which is typical of the New Jersey Pine Barrens. The northern pine snake is most often found in these sandy plant communities (Zappalorti et al, 1983; Burger and Zappalorti 1989). These communities are primarily dominated by pitch pine (*Pinus rigida*) with a somewhat sparse herb layer. The Stafford Forge WMA also has an assortment of wetland habitats in addition to the pine-oak forest. The shrub layer variously supports dense growths of dangleberry (*Gaylussacia frondosa*), lowbush blueberry (*Vaccinium pallidum*) and black huckleberry (*G. baccata*). Plants typical of New Jersey Pinelands upland settings are also common throughout the site.

### ***Pitch Pine - Scrub Oak Forests***

Portions of Stafford Forge WMA contain pitch pine-scrub oak sand ridge communities that have been cut over or burned several times. The remaining habitat is in varying stages or reforestation with native oaks and pines. Controlled burns (fire rotation) has been used as a forest management tool on most of this habitat.

### ***Pitch Pine Lowlands***

The pitch pine lowlands have somewhat less sandy soils, and extreme wet areas have Manahawkin Muck as the dominant soils. Higher ridge lines with Lakehurst or Woodmansie soils are nevertheless suitable for burrowing. These woods are largely mature to nearly mature pitch pine trees which have been thinned through selective harvesting. The canopy layer is approximately at 50% in most areas. The understory and herbaceous ground cover is highly diverse and contains ample forage for small mammals. Some of these sites blend into bottomland hardwoods with wetland cedar swamp streams and old cranberry bogs.

## **MATERIALS and METHODS**

### ***Best Management Practices***

The Department and HA will use and implement the Best Management Practices (BMP's) that are known to science (Landers et al 1980; Zappalorti et al, 1981; Frier et al, 1982; Brown 1993; Kingsbury et al, 2002; Bailey et al, 2006; Gerald et al, 2006). Each of the three (3) release sites will be located no further than 3,000 feet from the documented northern pine snake den locations that exist on the Stafford Township Municipal Landfill. The next step is to select areas within Stafford Forge to create fields and build pine snake refugia (artificial dens).

Release sites were chosen on August 14, 2006, and clearing work on the three management fields began on August 22, 2006. These management tasks will follow the guidelines of Frier and Zappalorti (1982); Kingsbury and Gibson (2002); Bailey et al (2006); and Zappalorti, personal observations.



This Habitat Management and Conservation Plan falls into two general tasks. These are:

1. **Habitat Preparation and Manipulation** - Creation and clearing of three (3) fields at selected suitable habitat sites that measure approximately 300 feet by 800 feet in size (or about 5.5-acres). These fields will provide forest-edge habitat suitable for basking and resting. The fields will also help to maintain open, canopy-free sandy areas as potential nesting habitat for female pine snakes. Similar portions of the 3 fields will be planted with Pennsylvania sedge and other native grasses taken from the old Stafford Landfill.

2. **Habitat Enhancement** - Within these three (3) fields, sand and log brush piles and berms will be made along the edges to provide ground cover, shelter, and basking areas. Two (2) hibernacula (artificial dens), will be constructed in the northern portion of each field. Each snake den will be completely encircled with a four foot high hardware cloth fence totaling 0.15 acres. Within the fenced areas, hollow logs, brush piles, cover boards and drinking water will be provided. Native grasses will be planted on the sandy soil to mimic typical nesting habitat (Burger and Zappalorti 1986 and 1991).

**Phase I** of this experimental research project was initiated on August 22, 2006, at three selected portions of the Stafford Forge WMA, in Ocean County (see **Figure 4**). The start-up funding for this experimental pine snake management project is being provided by the project sponsor, Walter's Homes, Inc. (*i.e.*, the clearing of the three fields, building the hibernacula, erecting the fences, preparing the nesting habitat, security gate, funding for the monitoring, *etc.*).

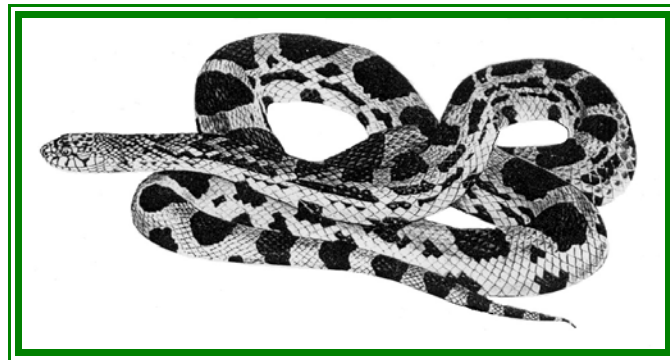

## CONCEPTUAL PINE SNAKE RELOCATION PLAN

Baseline data for this study plan was obtained from similar snake conservation and management plans conducted in the New Jersey Pine Barrens on the state “endangered” corn snake (*Elaphe guttata*), timber rattlesnake (*Crotalus horridus*), and “threatened” northern pine snake. This conservation plan incorporates 30 years of experience that HA and the Department has accumulated, while working with rare snake species in New Jersey. This relocation and monitoring plan was designed specifically for the pine snakes from the Stafford Business Park. It should be noted that these guidelines are based upon existing best-management practices (Zappalorti et al, 1981, Frier et al, 1982, Brown 1993, Kingsbury et al, 2002, Bailey et al, 2006; and Gerald et al, 2006).

### RELEASE SITE PREPARATION

**Management Fields** - There will be three (3) fields cleared along a sand ridge line (at an elevation of 70 feet or greater), within the pine-oak forest. The three fields will be separated by a 150 foot naturally vegetated buffer. Each field will be approximately 300 feet wide by 800 feet long (or about 5.5-acres). These three 5.5-acre fields are meant to replace the grassland habitat type being lost on the old landfill. Two snake dens (hibernacula) will be constructed on the northern edge of the fields, but separated by 250 feet from one another. Each hibernaculum will be encircled with a 0.15-acre fence to keep the snakes within the close vicinity of the dens. Three (3) of the dens will also have a larger, 3-acre perimeter fence for holding the pine snakes over a twenty month period (1.5 years). Only one access road will be cleared to bring in the front end loader, back-hoe, dump trucks, material to build the dens, fencing material, and other equipment needed to clear the fields and construct the artificial dens.

**Figure 1. Layout of the Northern Pine Snake Management Fields, Artificial Hibernacula, and Fences at Stafford Forge Wildlife Management Area, Ocean County, New Jersey.**

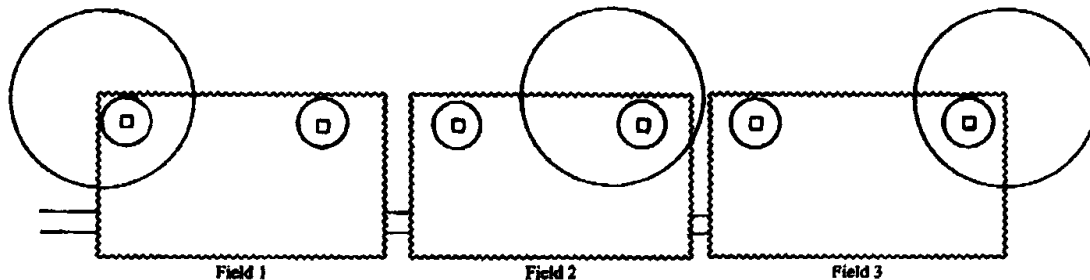

**Legend:** □ = Artificial Hibernaculum, ○ = Small Winter Fence, ○ = Large Summer Holding Corral.

Note: Diagrammatic drawing is not to scale.

**Construction of Snake Hibernacula** - In order to meet BMP, the recommended location for placement of the artificial dens should be on the north side of a management field for better afternoon sun exposure. Diagrams of artificial snake hibernacula are illustrated in **Figures 2 and 3**.

Step 1. After surface vegetation has been removed with a front-end loader and stockpiled, a backhoe should dig a trench 4.5 feet wide, 8.5 feet long, and 6.5 feet deep.

Step 2. A total of 22 railroad ties is needed for each hibernacula as well as several stumps, logs, branches and soil to cover the mound. Cut 6 of the ties in half (4 foot lengths).

Step 3. Lay two full length ties on the floor of the trench along the sides. Place two of the pre-cut ties on top of the full length ties, thus forming a rectangle. Secure the ties to one another with large nails; this will keep them together and prevent them from coming apart over a long period of time. Repeat the procedure 8 times so the ties form a rectangular box or crib.

Step 4. Four (4) inch diameter perforated PVC pipe (12 feet long) should be used as entrance and egress points, for a total of four - one in each compass direction. Secure the pipes in place with wooden oak stakes to prevent movement during back-filling. Drill two holes about three inches in from the front of the pipes, on top, and insert large spikes to prevent skunks or opossum from entering the den.

Step 5. Fill the opening with large stumps, logs, branches and sand, almost to the top. Make sure the ends of the PVC pipes are not blocked by debris and that they allow a snake to crawl in and out without obstacles.

Step 6. Place one final tie on the top, center of the crib to support the roof. Cover the top of the rectangular box with a 4 foot by 8 foot sheet of pressure treated 3/4 inch plywood, thus forming the roof. Cover the roof with plastic sheeting or tarpaper to protect the wood.

Step 7. Cover the roof with about 2 to 3 feet of sand. Stack more logs, stumps, and branches on the top of the sand, up to 4 feet high. Then cover the pile with more sand that was dug from the trench. Cover the entire mass until the mound is about 7 feet in height. Make sure the entrance of the PVC pipes are not blocked by debris and that they allow a snake to crawl in and out of the den, without any obstacles.

By using a 4 foot by 8 foot sheet of pressure treated 3/4 inch plywood for the roof, and railroad ties in the construction of the snake hibernacula, it's predicted they will last up to 25 years or more. Pressure treated ties and roof will greatly minimize termites from eating the wood. HA has supervised the construction of over 50 artificial snake dens at various locations in the New Jersey Pine Barrens (Zappalorti et al, 1994). The diagram and methods of construction for the wildlife shelters/snake dens are provided in this management plan. It is important to keep the entrance pipes free of debris, so they do not become blocked. Clogged entrance pipes will prevent the snakes from using them (Frier et al, 1983).

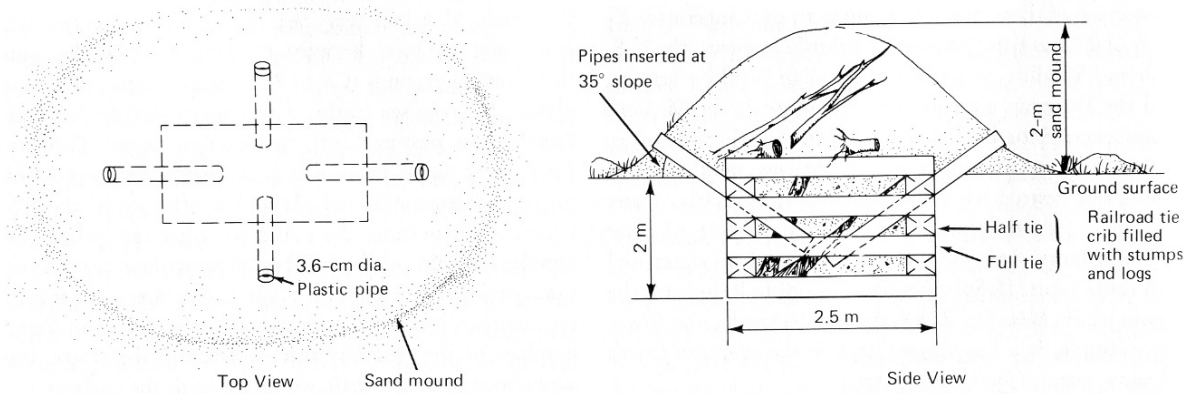

Figure 2. Top and side views of construction details for building an artificial snake den.

### Construction of Snake Hibernaculum

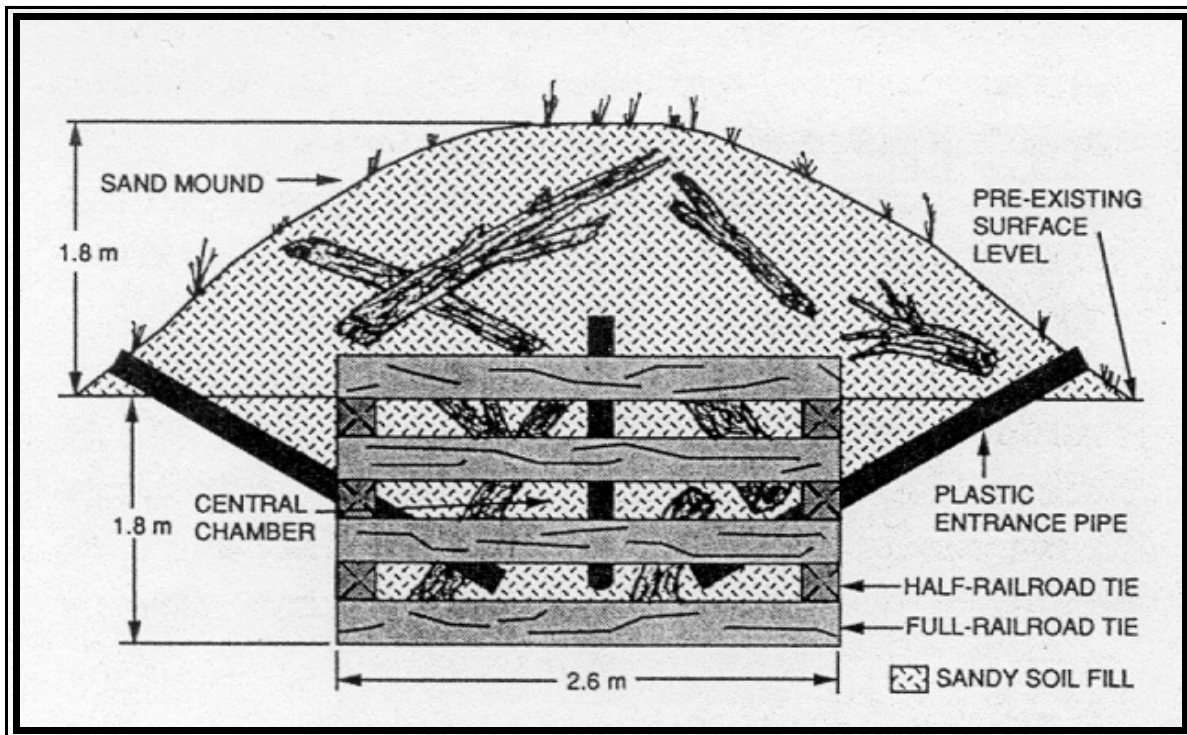

Figure 3. Side view of underground hibernation chamber for snakes and other wildlife. This drawing shows the method of construction using pressure treated railroad ties and 3 inch diameter, perforated PVC pipes. The entrance pipes should be set at a 35 degree angle, so snakes can easily move up and down them. Drawing by R. Zappalorti, Herpetological Associates, Inc.

***Erecting Fences*** - Once the three management fields are cleared and berms are created, six (6) artificial winter hibernation dens are built on the fields. The next step is to erect 4-foot high hardware cloth fences as holding corrals. The mesh size of the opening should be 1/4 inches. Six foot long metal posts should be used to erect the fences. Sturdy, rust resistant wire should be used to attach the hardware cloth to the metal post. The metal posts should be between 10 to 15 feet apart. Each fence will be covered with construction grade landscape fabric on the inside (the type that is used under stone to prevent weeds from growing). A hand-held rivet gun with large one-inch metal washers should be used to attach the fabric to the fences. Only the three larger 3-acre fences have to be covered with fabric, because they will be used for holding snakes during their active season. This is needed to prevent the snakes from seeing through the fence. If the snakes can see through the fences, they will spend most of their time rubbing their snout in an attempt to escape. The snakes will not only injure themselves by excessive probing and rubbing, but may also become overly stressed, which may effect their health (Kauffeld 1969). A metal folding ladder will be required at each field to allow researchers easy access to get over the fences to monitor and feed the snakes. Likewise, the larger 3-acre fenced areas will also need a ladder. The design of the ladders should be fashioned after the ones used to enter above ground swimming pools.

The 6 den fences will serve as sampling stations in the spring and fall. In other words, traps can be placed on the outside of the fence to capture snakes leaving the hibernacula in the spring and on the inside of the fence to capture snakes returning to the hibernacula in the fall. Starting in the spring of 2007, 4 traps will be set on each of the fences every spring and fall for the duration of the 7-year study.

### ***Preparation of Nesting Habitat***

Within each of the 6 small winter holding corrals, a 20 by 30 feet sandy section will be planted with native grasses. An attempt will be made to mimic typical nesting habitat (Burger and Zappalorti 1986 and 1991). Likewise, in the larger 3-acre summer holding fences, about 25% of each field will be made suitable as a pine snake nesting habitat, and managed as such. Pennsylvania sedge and other native grasses will be collected at the Stafford Landfill and spread-out on the surface of the fields. The root stock will allow the grasses to grow by the spring of 2007, and thereafter.

## **EXPERIMENTAL TREATMENTS FOR RELOCATED PINE SNAKES**

On September 21, 2006, all healthy adults and all hatchling northern pine snakes will be divided into equal groups and released at the 6 artificial dens (**Table 1**). The hatchling pine snakes, their egg shells, and shed skins will be placed into artificial nest chambers in the grassy, sandy area near the dens. This action will help the hatchling pine snakes with imprinting and learning the location of the new nesting areas and winter dens (Burger and Zappalorti 1986, 1991, 1992; and Zappalorti, personal observations). As mentioned previously, all six hibernacula will have a 0.15-acre fence around the dens. Additionally, 3 dens will have a larger 3-acre fence around the smaller winter fence (**Figures 1 and 4**). The large 3-acre perimeter fences will be removed after the winter of 2008, so the snakes will have easy access to the hibernacula. However, the smaller, 0.15-acre fences will be kept up, so we can monitor ingress and egress use of the dens by hatchling and adult snakes.



### ***Treatments for Years 2006 - 2008***

**Group One (Two Winters):** On September 21, 2006, thirteen (13) hatchling pine snakes and four (4) adult pine snakes will be released into a 0.15-acre enclosure. Following emergence in the spring, the pit tagged marked hatchlings and radio-implanted adults will be released into a larger 3-acre holding fence in mid-April of 2007. The 18 pine snakes will be monitored and fed weekly while in the enclosure. The snakes will be released into the forest in mid-April of 2008.

**Group Two (One Winter):** On September 21, 2006, twelve (12) hatchling pine snakes and four (4) adult pine snakes will be released into a 0.15-acre enclosure. Following emergence in spring 2007, the pit tagged marked hatchlings and radio-implanted adults will be released outside the holding fence by mid-April of 2007. The four adults will be monitored by HA via radio-telemetry for their entire activity season.

**Group Three (One Winter):** On September 21, 2006, twelve (12) hatchling pine snakes and five (5) adult pine snakes will be released into a 0.15-acre enclosure. Following emergence in spring 2007, the pit tagged marked hatchlings and radio-implanted adults will be released outside the holding fence by mid-April of 2007. The four adults will be monitored by HA via radio-telemetry for their entire activity season.

**Group Four (Two Winters):** On September 21, 2006, twelve (12) hatchling pine snakes, one (1) juvenile, and four (4) adult pine snakes will be released into a 0.15-acre enclosure. Following emergence in spring 2007, the pit tagged marked hatchlings and radio-implanted adults will be released into a larger 3-acre fence by mid-April of 2007. The 17 pine snakes will be monitored and fed weekly while in the enclosure. They will be released into the forest in mid-April of 2008.

**Group Five (One Winter):** On September 21, 2006, twelve (12) hatchling pine snakes and four (4) adult pine snakes will be released into a 0.15-acre enclosure. Following emergence in spring 2007, the pit tagged marked hatchlings and radio-implanted adults will be released outside the holding fence by mid-April of 2007. The four adults will be monitored by HA via radio-telemetry for their entire activity season.

**Group Six (Two Winters):** On September 21, 2006, thirteen (13) hatchling pine snakes and five (4) adult pine snakes will be released into a 0.15-acre enclosure. Following emergence in spring 2007, the pit tagged marked hatchlings and radio-implanted adults will be released into a larger 3-acre holding fence by mid-April of 2007. The 18 pine snakes will be monitored and fed weekly while in the enclosure. These snakes will be released into the forest in mid-April of 2008.

**Group Seven (One Winter in the Laboratory):** Because of poor health reasons (e.g., low body weight, injuries, or transmitter problems), 7 adults (3 males and 4 females), will be kept in the laboratory over the winter of 2006 - 2007. The 7 snakes will be kept individually, on natural Pine Barrens sand, and fed regularly. In March 2007, they will be cooled down and acclimated to outside ground temperatures, and placed within one of the appropriate treatment groups in early April of 2007. These snakes will be released into the forest in mid-April of 2007 or 2008, and monitored via radio-telemetry for the duration of the project.



### ***Care and Maintenance of Penned Snakes***

While being kept in the 3-acre fenced corrals, the diet of the pine snakes will have to be supplemented with both wild and laboratory rodents. The condition of the fenced enclosure and the health of the pine snakes should be checked a minimum of two times a week while snakes are present (2006 - 2008). Brush piles, hollow logs, and plywood will be strategically positioned within the snake holding pens to provide shelter and ground cover for the snakes. Cover objects will also provide safe retreats and hiding places for the pine snakes. Any shelter boards, brush, stumps, and other types of cover that are placed in one treatment, will also be placed in all the other treatments in the exact same way. The only variables that will differ between the three treatments will be the zero, one, and two winters spent in the dens and extra year of feeding and duration of containment.

The hatchling pine snakes will be released within a 0.15-acre holding area for winter hibernation, thus helping to establish fidelity for the artificial den system. Based upon past studies conducted with released hatchlings into artificial dens (Zappalorti et al, 1994; and Zappalorti personal observations), it is possible that a percentage of the surviving juvenile pine snakes will imprint and establish their activity range within the release areas. Thus a portion of the released hatchling pine snakes may adapt to the artificial dens, giving this experimental project its greatest success.

It should be noted that the above experimental treatments for pine snakes was fashioned after a relocation study that was carried out at the Savannah River Ecology Laboratory in Akin, South Carolina with a colony of gopher tortoises, *Gopherus polyphemus* (Tuberville et al, 2005). On the other hand, it is not likely that a high percentage of the adult pine snakes will acclimate to the new release sites. Perhaps by keeping the adult snakes penned for 20-months and/or 1.5-years, these snakes may adopt the new habitat as part of their activity range.

### ***Potential Prey***

Movements and habitat selection of predators (such as pine snakes and timber rattlesnakes) are assumed to be strongly associated with prey availability (Arnold 1993; Reinert, 1994). The diet of pine snakes is composed largely of small mammals, birds, lizards, and amphibians (Zappalorti, personal observations). The availability of suitable prey on the release site was evaluated during several visit in June and August 2006. An assessment of small mammal and other prey density was visually made by their presence and/or their sign. White-footed mice, voles, red and grey squirrels, and ground nesting birds were in high abundance. These species are known to be part of the diet of pine snakes (Zappalorti, personal observations). Within the corralled area at the release sites, some supplementation of prey will be necessary. Prey for the released snakes will be supplemented in a combinations of ways. Pitfall traps could be installed on the outside of the holding pens/corrals to sample and collect prey at the release sites. Collected small mammals will be fed to the corralled pine snakes to supplement their diet. Penned pine snakes will also be fed laboratory mice (as needed), to maintain normal body mass and good health of the relocated serpents. Ample prey animals are present on Stafford Forge WMA, and will serve as food resources for the free roaming relocated pine snakes (Reynolds et al, 1982; Arnold 1993).

## Focal Snakes

Through intensive fieldwork during 2006, EcolSciences, Inc. and HA captured 28 adult and 2 juveniles, for a total of 30 pine snakes. Of these, 22 adults were implanted with radio-transmitters prior to August 20, 2006. Because of poor body weight, injuries, or transmitter problems, 7 adults (3 males and 4 females), will be kept in the laboratory over the winter of 2006 - 2007. These 7 snakes will be placed within one of the appropriate treatment groups in early April of 2007. The two juveniles were not implanted because they are too small. Additionally, HA was commissioned to collect gravid female pine snakes and/or their eggs in June and July of 2006. This effort successfully resulted in the collection of 75 viable pine snakes eggs (from 8 clutches), which were incubated in HA's laboratory. If 100% hatching success is achieved, there will be a total of 105 pine snakes to be moved from the Stafford Business Park and released into Stafford Forge WMA (**Table 1**).

**New Wild Pine Snakes** - Additional, newly captured healthy adult and hatchling pine snakes could be trapped or found on the Stafford Landfill in the late summer and fall season, especially around known nesting areas and/or potential winter dens. Likewise, snakes may be captured in funnel traps along the perimeter drift fences. If new snakes are captured, they too can be relocated to one of the six selected release sites as described above. In order to reduce stress, wild adult pine snakes to be relocated, should be fitted with a radio-transmitter and released as soon as possible. If any new adult pine snakes are captured after the August 20<sup>th</sup> "safe window for surgical implantation (Rudolph, et al 1998)," these individuals should be pit tagged only and included in one of the experimental relocated groups (**Table 1**). Depending on age class, they can be released with the other pine snake groups in one of the six dens/holding pens at Stafford Forge WMA.

**Table 1. Planned Distribution of Northern Pine Snakes to be Released into Artificial Dens.**

Winter Treatments	Den Number	Adult Males	Adult Females	Juveniles	Hatchlings	* Totals
B = Two Winters	1	2	2	1M	12	17
A = One Winter	2	2	1	0	13	16
A = One Winter	3	2	1	0	13	16
B = Two Winters	4	2	1	1F	12	16
A = One Winter	5	2	1	0	13	16
B = Two Winters	6	3	2	0	12	17
C = One Winter in Laboratory	0	3	4	0	0	7
<b>Three Treatments</b>		<b>16</b>	<b>12</b>	<b>2</b>	<b>75</b>	<b>105</b>

\* **Note:** The above number of pine snakes represents the total to be released (or projected to hatch) at the time this study plan was written. More snakes may be captured before October 30, 2006.

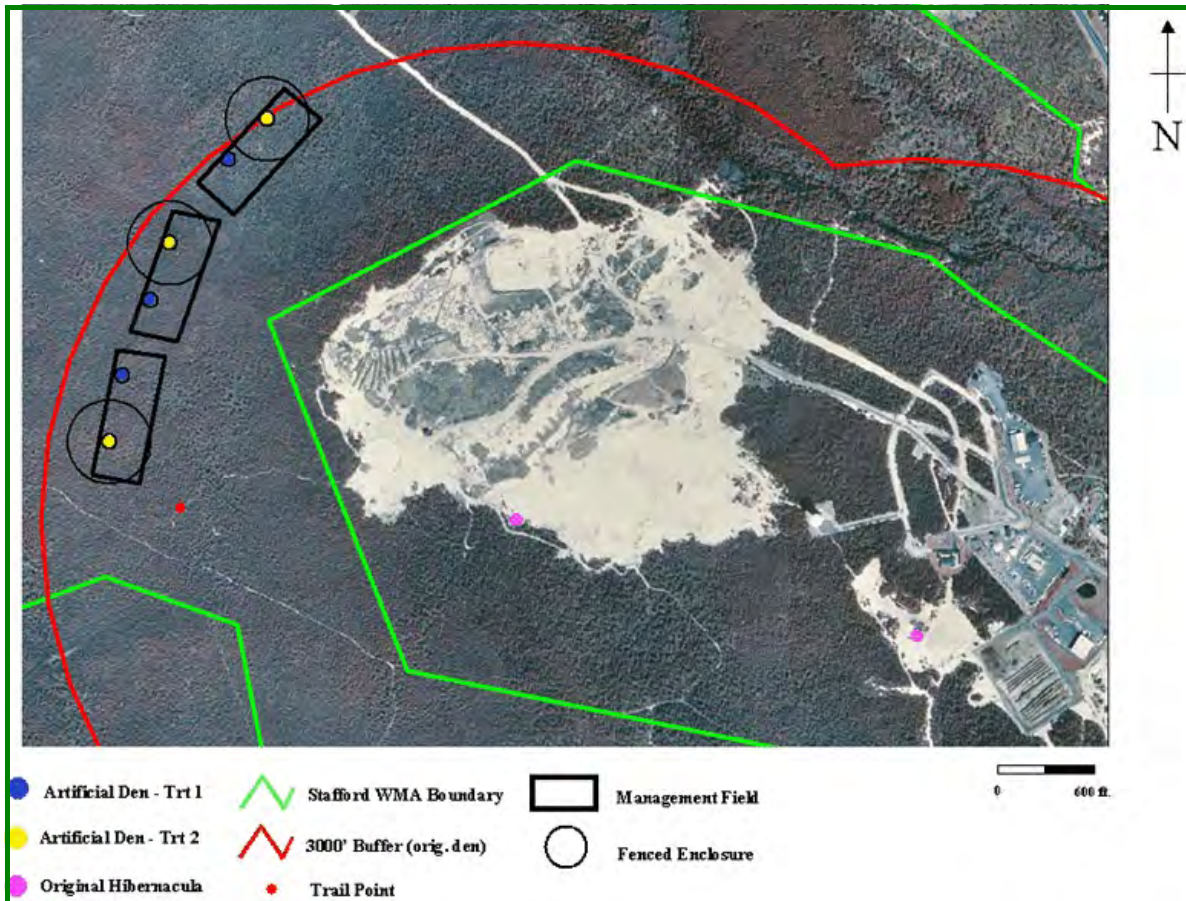

**Figure 4.** Aerial photograph showing the approximate locations of the three new experimental management fields on Stafford Forge Wildlife Management Area. The old Stafford Township Landfill is located about one half mile east of the new management fields. The 26 relocated adult pine snakes and the 74 hatchling pine snakes will be released into the artificial dens in early September, 2006. During the first winter’s acclimation period, both hatchling and adult pine snakes will be maintained together in these dens and outdoor enclosures. In the spring of 2007, 49 pine snakes will be released from the enclosures into the surrounding forest, while 52 will be kept another whole season and forced to hibernate in the artificial dens again. This map was prepared by Dave Golden, Endangered and Nongame Species Program, Division of Fish and Wildlife, NJDEP.

## FUTURE GRASSLAND HABITAT MAINTENANCE AND MANAGEMENT

Once the pine snake management fields at Stafford Forge WMA are cleared and properly manipulated and landscaped, there will be a need for periodic maintenance of the grassland habitat. Likewise, after the old Stafford Landfill is prepared, closed, and capped, it should be planted with native grasses. Grassland field habitat supports a wide array of wildlife, including small mammals, birds, reptiles, amphibians, butterflies and insects. In order to keep both of these areas as early successional fields, on-going management is required. Therefore, it will be necessary to develop specific mowing regimes for both of the capped landfill and the pine snake management field habitats. Since the Department owns and manages the Stafford Forge WMA, it is likely they will initiate a mowing or prescribed burning regime on their property. However, the on-going mowing regime at the capped landfill should be the responsibility of Stafford Township and Walter’s Homes, Inc.

Once the grasses are established in about two years, the mowing should begin. An important safety feature to protect wildlife that uses the fields is when the mowing should take place. A set rule for carrying out the field maintenance is that mowing should only be done during the winter. A safe window of time for the mowing or burning regimes is from November 1 through February 28 only! Mowing should never be done during the pine snake's active season (which is April through October). The specifics for these habitat managements plans are as follows:

### **Stafford Forge WMA**

Each field is approximately 300 feet wide by 800 feet long (or about 5.5-acres). These three fields should be mowed or managed using prescribed burning (during winter) every three years in order to keep trees and shrubs from growing. Ideally, native grasses such as Pennsylvania sedge, switch grass, and broom sedge should be present, intermixed with some patches of bare sand (about 15% of these fields should lack vegetation altogether). Most nesting area studies by Burger and Zappalorti (1986, 1991, and 1992) had little or no trees and shrubs, with intermittent patches of bare sand. Ground cover often consisted of Pine Barrens sand wort, *Hudsonia*, and Pennsylvania sedge. These open, sunny conditions provide suitable nesting habitat for pine snakes. These are the ideal conditions which are sought at the three pine snake management fields. Therefore, the recommended management regime for the nesting habitat is: Mowing or burning every three years in order to keep trees and shrubs from shading nesting areas.

### **Stafford Township's New Landfill**

The Memorandum of Agreement calls for the old existing landfill to be closed and capped. This action may be initiated sometime during the winter of 2006 - 2007 (December and January). The landfill will be covered with about two feet of earth and planted with rye grass to stabilize the soil. HA recommends that only native grasses approved by the Commission be used, such as Pennsylvania sedge, switch grass, and broom sedge. These grasses should be planted along with the rye grass. One way to obtain the root stock of the grasses is to collect the existing plants and humus which currently grows on the old landfill with a front end loader and dump truck. This material could be stockpiled and stored on site. Once the new landfill is completed, the stockpiled earth material could be spread-out equally over the top surface, thus providing the root stock of the desired native grasses. Once the grasses become established, a mowing regime will be necessary. Grassland habitat will provide suitable feeding areas for a variety of wildlife, including pine snakes. Many small mammals, birds, reptiles, amphibians and insects will use the grassland habitat. Rodents, such as meadow voles and white-footed mice will live in the grassland habitat, which is ideal conditions for pine snake foraging.

The on-going mowing regime at the capped landfill should be the responsibility of Stafford Township and Walter's Homes, Inc. The periodic management regime for the grassland habitat on the new Stafford Landfill is: Mowing every two years in order to keep the habitat as early successional fields (e.g., keep trees and shrubs from growing).



## **DISCUSSION AND SUMMARY**

Approximately 105 northern pine snakes will be released into six artificial hibernacula at three management fields on September 21, 2006, by the Endangered and Nongame Species Program staff, and assisted by HA. The breakdown of these snakes by age class is: 22 adults, 2 juveniles, and 75 hatchlings (if all the eggs are fertile and hatch). At the end of March 2007, 7 more adult pine snakes (3 males and 4 females), will also be released into an appropriate treatment group. Each den will have a small 0.15-acre fence around it to keep the snakes confined to the close vicinity of the dens. While penned within the holding fences, these pine snakes will have to be monitored carefully to make sure they are healthy, all are feeding, and no predation or vandalism has occurred. The corralled pine snakes should be checked a minimum of two days per week to ensure their good health and fitness. If they have not gone in on their own, once the cold weather arrives and nighttime frost begins, all snakes will be placed inside the entrance pipes of the dens. Daily checks will be made via radio-tracking and visual searches, to make sure all snakes have safely withdrawn into the winter dens.

In summation, management methods are suggested that have been proven effective with northern pine snakes, corn snakes, and timber rattlesnakes elsewhere in Ocean County, New Jersey (Frier et al, 1983; Zappalorti et al, 1994). It is probable that if these management guidelines are followed correctly, a large percentage of the relocated pine snakes collected at the Stafford Township Business Park (A.K.A. Stafford Township Municipal Landfill Site), should adapt successfully to suitable habitat within Stafford Forge WMA.

While a percentage of the adult pine snakes may attempt to return to their original capture locations within the Stafford Landfill in 2007, these proposed management plans may help to ensure the continued survival of most of the pine snakes in this population. Efforts to improve upon the existing habitat of these rare species will consist of increasing cover along the edges of the management fields, and the creation of critical habitats such as winter hibernacula, and nesting areas. This study plan suggests guidelines and recommendations for experimental management activities to be initiated at three management fields and relocation sites. It provides the technical background to carry out the needed management plans for the Stafford Township Business Park conservation project, as outlined in the Memorandum of Agreement.

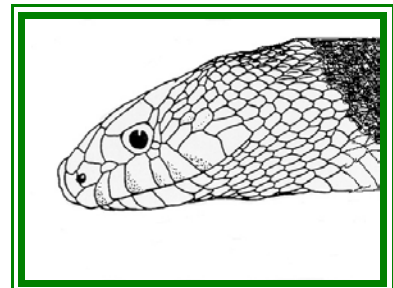



---

## PART II: RADIO-TELEMETRY AND LONG-TERM MONITORING PLAN

---

### INTRODUCTION

The Memorandum of Agreement requires a long term research and monitoring plan of the northern pine snakes collected at the Stafford Township Business Park. This report is intended to provide the details and criteria for that long term monitoring plan. Approximately 25 to 35 adult northern pine snakes will be monitored via radio-telemetry during 2007, and through 2013. These intensive field studies will be carried out at the Stafford Forge WMA, located in southern Ocean County, in the Pine Barrens of New Jersey. On page 21, we ask six important research questions to possibly be answered by this investigation, and these are the goals of this study. Radio-telemetry is the chosen tool to help reveal the answers to these questions, which will aid with the conservation and management of rare snakes in New Jersey.

All healthy male and female pine snakes captured at the Stafford Business Park were surgically implanted with radio-transmitters before August 20, 2006 (Rudolph *et al*, 1998). All healthy adult pine snakes should be monitored with radio-telemetry for up to 7-years. Starting in 2008, annual progress reports will be submitted to the Commission, the Department (NJDEP), and Walter's Homes, Inc. In July of year seven, all radio-transmitters should be removed from the study animals (by July 30, 2013). The snakes's health and fitness should be evaluated. Data on weight and snout-vent measurements should also be taken, and the snakes released back to their last capture locations. Year seven should also be dedicated to data analysis of the volumes of information collected over the previous six year study period, and writing the final report. One of the many objectives of this investigation should be that the end results, or portions thereof, are submitted to scientific journals for peer review and possible publication.



## **OBJECTIVES OF THE RADIO-TELEMETRY AND LONG-TERM MONITORING PLAN**

This proposed long-term radio-tracking and monitoring plan for the northern pine snake will include the following major tasks:

1. Obtain all the necessary authorization and permits from the New Jersey Department of Environmental Protection and the New Jersey Commission.
2. Initiate a 7-year long-term monitoring program of 28 relocated pine snakes at release sites within Stafford Forge Wildlife Management Area, including intensive radio-tracking of all adults (equal percentage of males to females if possible).
3. Initiate a 7-year monitoring program of 10 non-relocated pine snakes within the Stafford Forge Wildlife Management Area, including intensive radio-tracking of these adults (equal percentage of males to females if possible).
4. The perimeter drift fence will be maintained and monitored for four (4) years. Snake traps will be kept on both sides of the fence for two (2) years, and only on the outside of the fence for the remaining two years. The fence will be repaired and kept functional during the 4-year on-going studies. The traps will be checked every 48 hours. Any new adult pine snakes caught in the perimeter fence traps will be fitted with radio-transmitters (up to 10 snakes).
5. The exact same data sets will be recorded for both the relocated (28 individuals) and the non-relocated (10 individuals) northern pine snakes. This will be done for a direct comparison of the snake's movement patterns and seasonal behavior.
6. All radio-telemetry monitored pine snake locations will be recorded with a Geographic Information System (GIS) unit and later plotted on activity range maps.
7. All relocations of the radio-transmitter equipped snakes will be plotted to scale and activity range boundaries will be estimated using the Minimum Convex Polygon (MCP) method (Southwood, 1966) and the Kernel method (Hooge et al. 1999).
8. Year seven of this study will be dedicated to removing all radio-transmitters from the study animals and releasing the snakes to their last recapture location by August 1<sup>st</sup>.
9. Year seven will also be dedicated to data analysis of the volumes of information collected over the six year study period, and final report writing.
10. An objective of this seven-year investigation should be that the end results are submitted to peer reviewed, scientific journals for possible publication.
11. Data analysis and final report writing will be the responsibility of both the Endangered and Nongame Species Program (the Department) and HA.

## **IMPORTANT RESEARCH OBJECTIVES**

As previously mentioned, the primary objective of this effort is to avoid direct impacts to the known population of pine snakes that is using the Stafford Business Park site for foraging, nesting, and overwintering. Coupled with this is a long-term monitoring program to evaluate whether pine snakes moved from the Stafford Business Park can adjust to their new den locations and to the loss of habitat associated with the Business Park redevelopment..

The success of this project will be evaluated in various ways and the long-term monitoring program will address the following five (6) questions:

1. Can adult and hatchling northern pine snakes establish themselves and overwinter successfully in constructed artificial hibernacula after being moved to a different area within their known activity range?
2. Do non-relocated northern pine snakes (or other snake species) from the existing Stafford Forge Wildlife Management Area population begin to use the artificial hibernacula constructed in the three management fields on their own?
3. How do the spatial movements and other behaviors (*e.g.*, habitat use, foraging, mating, nesting, and denning) of the relocated pine snakes differ from the non-relocated pine snakes?
4. Do pine snakes from this population (both those moved to the management fields and others) attempt to move back onto the redevelopment area of Stafford Township Business Park during the construction period, and if so, does this tendency diminish over time?
5. Do a higher percentage of northern pine snakes (adult and juvenile) return to, and overwinter in, the artificial hibernacula when they are kept in an enclosed area around the hibernacula and fed for two winters versus only a single winter?
6. Will relocated and non-relocated gravid female northern pine snakes from this population begin using the three management fields as nesting habitat in future years?

These are all important conservation and management questions that need to be answered in order to develop policies that are crucial to the survival of pine snakes and other species. While it has already been proven that snakes will successfully hibernate in artificial dens and return to them year after year (Burger et al, 1988b; Zappalorti et al, 1994), the above questions have not yet been addressed.

## **METHODS AND RADIO-TELEMETRY PROCEDURES**

In 2007, radio-telemetry will be used to monitor the behavior of 13 relocated, free-ranging pine snakes (including 3 snakes that were held in the laboratory). Additionally, as they are captured in the drift fences or by random searching, up to ten (10) non-relocated pine snakes will also be radio-tracked. The additional 12 relocated adults kept in the 3-acre corrals for 1.5 years will be released in mid-April of 2008, and also radio-tracked in the forest. Thus, up to 35 adult pine snakes will be monitored via radio-telemetry from 2008 through 2010.

### ***Radio-transmitters***

Powerful radio-transmitter packages will be purchased from the AVM Instrument Company, Holohil Systems Ltd., or some other supplier, that are specially designed for large, fast moving snakes. Some commercially available transmitter packages are normally constructed for use with mammals or birds and are generally unsuitable for use with snakes (Reinert 1992 and 1994). The snake transmitters will be designed so that their weight represents less than 4% of the body mass. Locational units (2 to 6 grams total mass) with transmission distances of 800 to 2000 m will be used in most specimens (Gregory et al, 1987). The transmitters will be surgically implanted in the coelomic cavity following the general procedure described by Reinert and Cundall (1982) with recent improvements and modifications (Reinert, 1992). All surgical procedures will be performed by the investigators (HA staff). As transmitter batteries are predicted to terminate, they will be replaced by new transmitters from the supplier. All transmitter equipped snakes will be recaptured at the end of the seven year study and the radio-implants will be removed. After recovery from surgery, the snakes will be released at their exact capture location (Reinert et al, 1988a and 1988b).

### **MONITORING SNAKES AT THE ARTIFICIAL DENS (2006 - 2007)**

Approximately 98 northern pine snakes will be released into six artificial hibernacula at three management fields on September 21, 2006, by the Department and HA. The breakdown of these snakes by age class is: 22 adults, 2 juveniles, and 75 hatchlings (if all the eggs are fertile and hatch). It is essential that these penned snakes are monitored, cared for, and fed with proper husbandry techniques. Therefore, each study group of snakes has to be checked a minimum of two days a week over the remainder of 2006, and the entire 2007 active season. On one of these check days an attempt will be made to locate each snake within the corral, check its health, and feed it. This will be a daunting task with great responsibility (*i.e.*, the health and survival of the snakes depends upon proper husbandry). We will also monitor ingress and egress from the artificial dens starting in the spring of 2007. Monitoring the traps on the small den fences every spring and fall (four on each fence), will provide information on survivorship and success of artificial hibernacula for juveniles, which will help answer the research questions. We will record the snake's SVL length and weight each spring and fall. We will also record the same data when adult snakes are collected in the summer when transmitters are changed.

## **MONITORING THE PERIMETER DRIFT FENCE**

The perimeter drift fence will be maintained and monitored for 4 years. Snake traps will be kept on both sides of the fence for two (2) years to capture pine snakes that may be leaving the SBP construction area, but most snakes should be collected or displaced by the end of year two. After 2008, traps will be placed only on the outside of the fence for the remaining two years (2010). The fence will be repaired and kept functional during the 4-year on-going drift fence trapping studies. The traps will be checked every 48 hours during the snakes active season (April through October). Any new adult pine snakes caught in the perimeter fence traps will be fitted with radio-transmitters (up to 10 snakes), and monitored for the remainder of the investigation. Hatchlings and juveniles caught in the traps (or by random searching), will be injected with Pit Tags as part of the mark and recapture program.

## **EXPERIMENTAL RESEARCH DESIGN**

Because relocating snakes is a purely experimental undertaking, we will test two relocation techniques as part of this plan. The relocated snakes will be divided into one of two groups and assigned to one of two treatments, including a one-winter treatment and a two-winter treatment. In the one-winter treatment, snakes will be kept in an enclosure (0.15-acre in size) around the artificial hibernacula for one winter (winter 2006/2007). In the two-winter treatment, snakes will be kept in small enclosures (0.15 acre) around the artificial hibernacula for the first winter (winter 2006/2007), and will be held in a larger enclosure (3 acre) for an additional 10 months (May 2007 through April 2008). The design of these treatments was fashioned after a relocation study that was carried out at the Savannah River Ecology Laboratory in Akin, South Carolina with gopher tortoises (Tuberville et al, 2005). In this study, relocated tortoises held for a longer time in enclosures were more likely to take up residence at the release sites.

Each of the three management fields will have hibernacula representing the zero winter (7 adult snakes kept in the laboratory), one-winter treatment, and the two-winter treatment. Within the management fields, treatments will be assigned randomly to the hibernacula. The study snakes will be divided into three groups and given different research treatments. Adult pine snakes from each treatment group (equal percentage of males to females if possible), will be fitted with radio-transmitters and monitored for the duration of the study. Up to 26 relocated snakes will be radio-tracked over the seven-year study period. At each snake relocation 7 climatic and 10 structural habitat variables will be recorded to identify habitat use and selection. Directional movements and locational data will be recorded, along with activity and any interesting behavior. All telemetry monitored pine snake locations will be recorded with a Global Positioning System (GPS) and mapped.

## RESEARCH GROUPS

***Radio-tracked Group No. 1 - Two Winters.*** This group of 4 adults, 1 juvenile, and 12 hatchling pine snakes will be released from the small winter fence, into a 3-acre holding enclosure on or about April 17, 2007. The 4 adult individuals will be radio-tracked and located in the enclosure 2 days a week. At each location basic climatic variables will be recorded and the snake's activity will be noted, along with any interesting behavior. These 4 adults and the 12 hatchling pine snakes will be released outside the corral in the spring of 2008. Once released outside the corral, these 4 adult individuals will be radio-tracked for at least 5 years, and possibly located 3 days a week.

***Radio-tracked Group No. 2 - One Winter.*** This group of 3 adults and 13 hatchling pine snakes will be released from the 0.15-acre enclosure on or about April 17, 2007. These 3 adult individuals will be radio-tracked for at least 6 years, and located 3 days a week

***Radio-tracked Group No. 3 - One Winter.*** Similar to group two, this group of 4 adults and 13 hatchling pine snakes will be released from the 0.15-acre enclosure on or about April 17, 2007. These 4 adult individuals will be radio-tracked for at least 6 years, and located 3 days a week.

***Radio-tracked Group No. 4 - Two Winters.*** This group of 3 adults, 1 juvenile, and 12 hatchling pine snakes will be released from the small winter fence, into a larger 3-acre holding enclosure on or about April 17, 2007. The 3 adults will be radio-tracked and located within the enclosure 2 days a week. At each location basic climatic variables will be recorded and the snake's activity will be noted, along with any interesting behavior. These 3 adults, 1 juvenile, and 13 hatchling pine snakes will be released outside the corral in the spring of 2008. Once outside the fence, these 3 adult individuals will be radio-tracked for at least 5 years, and possibly located 3 days a week.

***Radio-tracked Group No. 5 - One Winter.*** Similar to groups two and three, this group of 3 adults and 13 hatchling pine snakes will be released from the small 0.15-acre enclosure on or about April 17, 2007. These 3 adult individuals will be radio-tracked for at least 6 years, and possibly located 3 days a week

***Radio-tracked Group No. 6 - Two Winters.*** This group of 5 adults and 12 hatchling pine snakes will be released from the small winter fence, into a 3-acre holding enclosure on or about April 17, 2007. The 5 adult individuals will be radio-tracked and located in the enclosure 2 days a week. At each location basic climatic variables will be recorded and the snake's activity will be noted, along with any interesting behavior. These 5 adults and the 12 hatchling pine snakes will be released outside the corral in the spring of 2008. Once released outside the corral, these 5 adult individuals will be radio-tracked for at least 5 years, and possibly located 3 days a week.

**Radio-tracked Group Seven (One Winter in the Laboratory):** Because of poor body weight, injuries, or transmitter problems, 7 adults (3 males and 4 females), will be kept in the laboratory over the winter of 2006 - 2007. These 7 snakes will be placed within one of the appropriate treatment groups in March of 2007. These snakes will be released into the forest in mid-April of 2007 or 2008 and monitored thereafter via radio-telemetry through 2013.

### **Additional Radio-tracking on Non-relocated Pine Snakes**

In order to make direct comparison between relocated pine snakes and non-relocated pine snakes, we recommend radio-tracking up to 10 resident pine snakes that are captured coming into the Landfill site in traps or along the fences (of equal sex ratios if possible). HA's herpetologist will be responsible for radio-tracking the 10 non-relocated pine snakes for up to 7 years of this project. While capturing new snakes may require intensive searching in Year 1, this effort will be balanced by the fact that many of the moved snakes will not required intense tracking effort during 2007 because 12 of them will be contained and corralled in the 3-acre fenced area (Group No's. 1, 4, and 6), for the entire 2007 season. Capturing and monitoring non-relocated snakes is essential if we are to compare habitat use, movements, and home range size with relocated pine snakes. As with the moved snakes, these non-relocated pine snake will be radio-tracked and located 3 days a week. At each location 7 climatic and 10 structural habitat variables will be recorded to identify habitat use (see the sample radio-tracking data sheet below). The snake's activity will be noted along with any interesting behavior. All telemetry monitored pine snake locations will be recorded with a Global Positioning System (GPS) and mapped. The same adult pine snakes should be monitored for the duration of the project, and throughout the complete activity season (Reinert 1993). Radio-tracking snakes for five to six activity seasons will provide information on possible movements back to their original home range, habitat use, activity range size, overwintering sites, nest site selection, and more important, the survivorship of relocated pine snakes.

**Study Specimens** - While in the laboratory, all snakes will be housed in individual, sanitized aquaria in HA's holding facility, physically separated from other captive animals (especially snakes). These efforts are taken to ensure against the spread of diseases from captive to wild populations. All pine snakes encountered on the study area will be permanently marked for future identification with intra-peritoneal implanted passive integrated transponder tags (Pit Tags). All snakes will also be measured, sexed, weighed, examined for a series of taxonomically useful morphological characteristics, and palpated for food items and the presence of eggs. Each pine snake will have its own capture data sheet, and subsequent radio-tracking data sheets (see sample data sheets on the next two pages).

**Temporary Holding for Surgery** - Sterile zoological husbandry procedures should be used in all pine snake holding facilities. Research pine snakes should not be kept in the same cages with any other snakes. This is proper housing husbandry protocol for research snakes being held temporarily in captivity (Kauffeld 1969). If sick or injured individual pine snakes are collected from the site, they would be treated accordingly by HA, or by a veterinarian. However, common sense dictates that all pine snakes should be held in quarantine, isolation and with sanitary husbandry protocols at all holding facilities (Kauffeld 1969).



*Herpetological Associates, Inc.*  
**Sample - Northern Pine Snake Radio-tracking Data Sheet - Page 1**

---

---

**Location:** Stafford Forge WMA, **Township:** Stafford, **County:** Ocean, **State:** New Jersey

**Field Number:** \_\_\_\_\_ **Frequency Number:** \_\_\_\_\_ **Pit Tag Number:** \_\_\_\_\_

**Sex:** \_\_\_\_\_ **Relocation Number:** \_\_\_\_\_ **Date of Relocation:** \_\_\_\_\_ **Time:** \_\_\_\_\_

---

**Activity of Snake** (*e.g.*, crawling or moving, basking outstretched, basking coiled, partially or totally concealed): \_\_\_\_\_.

---

**Climatic Habitat Variables at Snake Relocation**

**Surface Temp in Sun:** \_\_\_\_\_ **Surface Temp in Shade:** \_\_\_\_\_ **Surface RH:** \_\_\_\_\_

**Ambient Temp @ 1 meter:** \_\_\_\_\_ **Ambient RH @ 1 meter:** \_\_\_\_\_ **Soil Temp:** \_\_\_\_\_

**Soil Moisture:** \_\_\_\_\_ **Snake in Sun or Shade:** \_\_\_\_\_ **Weather:** \_\_\_\_\_

---

**GPS Data**

**New Location** (Yes or No)? \_\_\_\_\_ **GPS Reading Taken** (Yes or No)? \_\_\_\_\_

**GPS File Number:** \_\_\_\_\_

**Latitude (N):** \_\_\_\_\_

**Longitude (W):** \_\_\_\_\_

---

**Structural Habitat Variables at Snake Relocation**

**Forest Type:** \_\_\_\_\_ **Tree Canopy Type:** \_\_\_\_\_ **Understory:** \_\_\_\_\_

**Ground Cover Type:** \_\_\_\_\_ **Depth of Ground Cover:** \_\_\_\_\_

**Dominant Vegetation:** \_\_\_\_\_

---

---

*Herpetological Associates, Inc.*  
**Sample - Northern Pine Snake Radio-tracking Data Sheet - Page 2**

---

---

**Structural Habitat Variables at Snake Relocation**

**Percent Canopy Closure:** N: \_\_\_\_\_ E: \_\_\_\_\_ S: \_\_\_\_\_ W: \_\_\_\_\_ = **Total:** \_\_\_\_\_

**Distance to Nearest Overstory Tree:** \_\_\_\_\_ **DBH:** \_\_\_\_\_ **Species:** \_\_\_\_\_

**Distance to Nearest Understory Tree:** \_\_\_\_\_ **DBH:** \_\_\_\_\_ **Species:** \_\_\_\_\_

**Distance to Nearest Woody Shrub:** \_\_\_\_\_ **Height and Species:** \_\_\_\_\_

**Distance to Nearest Fallen Log:** \_\_\_\_\_ **Distance to Nearest Mammal Burrow:** \_\_\_\_\_

**Approximate Distance and Direction to Nearest Known Nesting Area:** \_\_\_\_\_

**Approximate Distance and Direction to Nearest Known Winter Den:** \_\_\_\_\_

**Describe Habitat and Other Notes of Interest:** \_\_\_\_\_

\_\_\_\_\_  
\_\_\_\_\_

**Photograph Taken (Yes or No)?** \_\_\_\_\_ **How Many?** \_\_\_\_\_

**Observer's Name:** \_\_\_\_\_

**Time Data Collection was Completed:** \_\_\_\_\_

**Draw a Sketch of Snake's Body Position:**

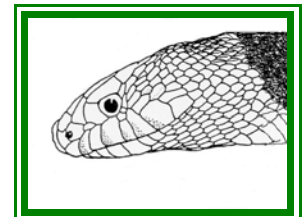

### ***Habitat Use, Movements, and Behavior***

During the radio-tracking phase of this study, up to 35 monitored specimens will be located a minimum of 3 days a week. At each relocation, 7 climatic and 10 structural habitat variables will be recorded. All measured variables will be identical to those used in other radio-tracking studies for comparison (Reinert and Zappalorti 1988a; Burger and Zappalorti 1988 and 1989). Over the duration of the study, a series of 100 randomly selected sites within the study area will be analyzed for habitat structure using the same variables as those collected at the 35 pine snake locations. Of the 100 randomly selected sites needed, 25 data sets will be taken over a four-year period. The random habitat data points collected will be compared with the snake's relocation sites during the snake's active season. Twenty five random points will be taken each year between 2008 and 2011 (Reinert and Zappalorti 1988a; Burger et al, 1988 and 1989). A comparison of these random sites with snake selected sites will assist in identifying structural elements important in the habitat selection process within the available habitat.

Climatic conditions on the study site will be monitored continuously with recording hydro-thermograph and micro-processor based temperature recorders (HOBOS), placed in representative habitat types within Stafford Forge Wildlife Management Area. These instruments will constantly record the general climatic conditions at typical pine snake habitat on the study area (Reinert and Zappalorti 1988a and 1988b).

The locations and movements of all snakes will be plotted to scale via a Geographic Information System (GIS), on a base map of the Stafford Forge Wildlife Management Area study site. The behavior of snakes at the time of location will be categorized to assess daily and seasonal behavior patterns. Particular attention will be paid to breeding events, nesting events, foraging behavior and feeding events (Babis 1949; Arnold 1993; and Fitch 1999). The movement parameters evaluated will include: total activity range area, monthly time series activity areas, total range length, total movement distance, and mean distance moved per day (Reinert and Zappalorti, 1988a; Reinert, 1992).



## **PROCEDURES TO CALCULATE ACTIVITY RANGES AND PARAMETERS**

An activity range is defined by Gregory, *et al.* (1987) as “an integrated expression of an animal’s location and movements over a specific time interval.” The activity range of a snake includes all movements between spring egress, spring and summer movement patterns, and fall ingress. The size and shape of the activity area, and its intensity of use reveal information on the species total activity range, and seasonal habitat requirements. The habitat types used, as well as their specific activity range movement boundaries, provides a diagrammatic expression of the space required to complete all activities (hibernation, mating, oviposition, foraging, etc.). This visual expression can be useful when determining minimum size of Wildlife Preserves and the areas that should be protected for pine snakes, corn snakes, and timber rattlesnakes (Reinert and Zappalorti 1988a and 1988b).

A Biologist from the Department (NJDEP) will assist HA with the collected GPS movement data. This Biologist will help analyze the data and calculate the activity range of all radio-tracked pine snakes. Locations of transmitter equipped snakes will be plotted to scale and activity range boundaries will be estimated using the Minimum Convex Polygon (MCP) method (Southwood, 1966), and the Kernel method (Hooge et al, 1999). The MCP method was chosen for its simplicity, historic prominence, and ease of comparison with existing data on reptilian activity (Brown et al, 1976; Jennrich et al, 1969; Reinert et al, 1982; Reinert et al, 1988a). The activity range of the convex polygon method represents the area enclosed by a perimeter drawn from the outermost plotted locations of the snake on a map. The activity range map provides the size and a crude shape of the habitat areas used by the radio-tracked snake (Southwood, 1966).

The Kernel method makes home range-size predictions by clustered habitat use with 50% and 95% isopleths (Kernohan et al, 2001; Seaman et al, 1996), which is an improved and more accurate home-range program. Both methods will be used to calculate the pine snake’s activity range parameters during this investigation (Reinert, 1994).

### **Global Positioning System (GPS)**

All telemetry monitored pine snake locations will be recorded with a Global Positioning System (GPS) unit and later plotted on maps by the Department’s Biologist. Snake activity and relocation sites will be recorded by GPS and plotted on 2002 aerial photographs, soil maps, and/or U.S.G.S. topographic maps (via GIS) to later profile habitat conditions at snake selected sites, activity range size, and movements. Habitat structure and vegetative composition based on visually dominant plant species will also be recorded to analyze habitat use. An activity (home) range for each individual snake will be plotted on a map using the Minimum Convex Polygon (Reinert 1994; Reinert et al, 1988a and 1988b), along with a second method which is a more improved home-range program known as the “Kernel Method” (Kernohan, et al, 2001; Seaman et al, 1996). Data collected through radiotelemetry will assist the Department and the Commission to better understanding the movement patterns and selected habitat used by relocated snakes at in Stafford Forge WMA.

## ***Data Analysis***

The collection of quantitative data will allow for an assessment of the habitat use by 35 free roaming pine snakes. Spatial movements, habitat use, and behavior of pine snakes will be recorded, and if possible photographed in the field. The analytical methods used will follow the recommendations of Reinert (1992) for radiotelemetric field studies of snakes. The movements and home range data analysis will be calculated using the Kernel and MCP programs. Appropriate statistical methods will be used to compare spatial movements, habitat use, and survival between snakes from the one-winter treatment, snakes from the two-winter treatment, and non-relocated snakes.

## **FUNDING, BUDGET, AND REPORTING REQUIREMENTS**

### ***Responsibilities***

*Division of Fish and Wildlife:* Primary oversight of the implementation of this plan resides with the Department. Department staff will help coordinate the habitat enhancement and den construction activities at the outset of the project. Staff biologists will also be responsible for the physical relocation of the snakes in September 2006. Other oversight responsibilities will include regular visits to the site to assess conditions of management fields and artificial dens, coordinating with HA to evaluate the project's status and progress, attending meetings, reviewing and issuing scientific collecting permits, and maintenance of management fields. Additionally, the Department will take the lead role in analyzing all of the data for the annual and final reports. The Department will coauthor (with HA) all reports for this project. Before any data from this project is submitted for publication and peer review, (other than annual reports and a final report), it will only be done under the mutual consent of the Commission, the Department, Walter's Homes, Inc., and HA. Beginning in Year 4 of the project (2010), Department staff will begin working on manuscripts in an effort to publish some of the findings of this study in a peer-reviewed journal.

*Herpetological Associates:* HA will help with the den construction and habitat enhancement activities at the beginning of this project. HA will monitor the perimeter drift fences and traps for 4-years. All radio-tracking and habitat data collection will be the responsibility of HA. This will also include ordering and purchasing all the needed equipment and supplies for this fieldwork. Furthermore, HA will conduct all surgical implantations of radio transmitters into study snakes. At the end of each field season, HA will provide Department Staff with a copy of all the data from the current season's fieldwork and will coauthor (the with Department) all annual and final reports.

*Walter's Homes, Inc.:* Walter's Homes, Inc. will make annual payments to both the Department and HA to cover the expenses of that year's work. These payments must be submitted to the Department no later than July 1<sup>st</sup> of any given year, and will be for the amount designated in the detailed budget of this plan (see **Table 16**). HA will submit invoices on a monthly basis, for only the work already completed.



**Budget** - The total cost of this seven-year project (not including habitat enhancement and den construction) comes to **\$789,609.80**. Of this seven-year total, the Department will receive \$127,250 (**Table 16**), and HA will receive \$662,359.80 over the seven year investigation (**Tables 2 through 15**). Under the “Memorandum of Agreement” between Ocean County, Stafford Township and the Commission, regarding the Stafford Business Park Redevelopment project, Walter’s Homes, Inc. (the project sponsor), has agreed to fund all costs associated with this plan. These include habitat enhancement (management field creation), artificial den construction, equipment costs, radio receiver and antenna rentals, supplies, and staff salaries.

The cost of field equipment, surgical supplies, the 40 radio-transmitters, and purchasing mice to feed the snakes is itemized in the appendices (**Table 2**). The direct and indirect costs of labor and salaries are itemized in **Table 3**, which is only representative of the annual cost for years 2006 and 2007. The details of all the costs associated with the radio-tracking aspect of this project are also chronicled in **Table 3**. Moving forward, each subsequent year of this investigation has its own costs **Tables**. The additional **Tables** (*e.g.*, **4 through 15**), show the annual costs for the on-going radio-tracking and monitoring of 35 pine snakes.

### ***Reporting***

Starting in December of 2008, preliminary annual reports will be prepared and submitted to the Commission and the project sponsor, Walters Homes, Inc.. These abstracted annual reports will document the progress of the long-term monitoring program and evaluate the need for mid-course modifications to this Research Study Plan. These reports will include a brief summary and highlights of the data collected during the previous year. The annual progress reports will include movement parameters showing the general activity range area for the surviving intensively monitored pine snakes. A composite map showing movement patterns of the radio-tracked snakes will also be provided. When possible, digital color photographs will be used to document snake behavior. Telemetry data for each of the radio-tracked snakes will be presented graphically on geo-referenced color aerial photographs. The discussion section of the annual report will assess the collected data in terms of the 6 primary questions and associated detailed considerations posed earlier that this 7-year study strives to answer. While it may be difficult during the early study years to fully address the 6 questions, preliminary conclusions will be drawn from the data compiled during the 2008 study period, and the previous year. Any proposed changes to the study protocols will be presented along with documentation as to the need for the changes. Following the completion of the 7-year study, a final report will be prepared and submitted to Commission and Walter’s Homes, Inc. All of the data collected during the study will be compiled and evaluated to address the six primary questions in a comprehensive manner.

## **DISCUSSION AND SUMMARY**

This investigation will extend for seven years, beginning in August 2006 and ending in August 2013. The final report will be submitted on or about **January 31, 2014**. This is a long term pine snake monitoring program that will attempt to document the level of success possible, following the relocation and movement of northern pine snakes from the Stafford Township Business Park to the Stafford Forge WMA. Radio-tracking will be the main research tool to monitor free-roaming adult pine snakes at various levels of intensity for 7 years. During July of year seven, all transmitters will be removed from the implanted study specimens and the snakes will be released at their most recent (last) capture locations.

Annual reporting will occur in January of each year (beginning January 2008) and a final project report will be completed in January 2014. This should be considered a dynamic plan and one that can be modified and improved upon as more information is gathered through monitoring and movement patterns of the relocated pine snakes. We thank the project sponsor, Walter's Homes, Inc. and the Commission for giving us the opportunity to conduct this important research project.

*Respectfully Submitted,*

By

**Robert T. Zappalorti**  
**Herpetological Associates, Inc.**  
575 Toms River Road  
Jackson, New Jersey 08527

and

**Dave Golden**  
**Division of Fish and Wildlife**  
Endangered and Nongame Species Program  
New Jersey DEP, Trenton, New Jersey

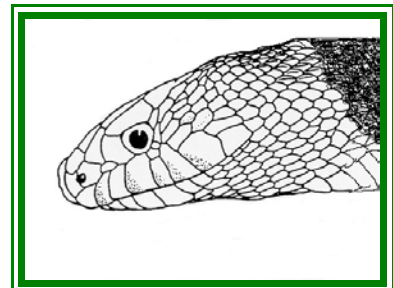

# ***APPENDICES***

**Tables 2 through 16**

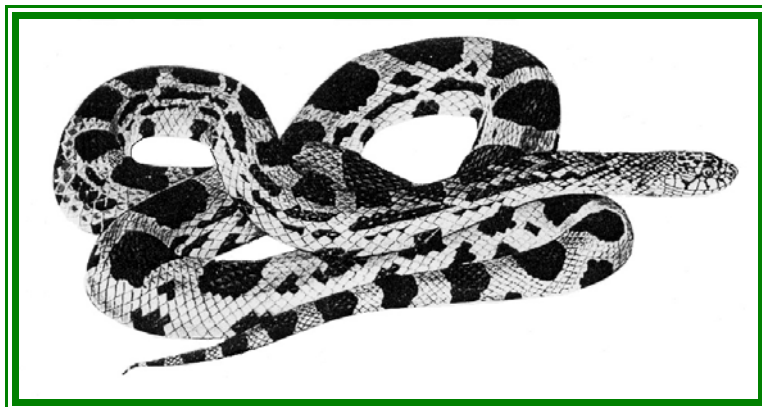

**Table 2. Material and Equipment Needed to Carry Out the Pine Snake Monitoring and Radio-Tracking Programs in years 2006 and 2007.**

Equipment and Hardware Cost Description					
		Items	Price	No. of units	Cost
1.	Radio-transmitters	Holohil SI-2 Transmitters	\$300.00	40	\$12,000.00
2.	Surgical Supplies	Anesthetic, sutures, scalpel blades, antiseptic, etc.	\$200.00	NA	\$200.00
3.	3 Radio Receivers	WMI TXR-200S radio receiver	\$10.00/day rental	124 Days/Season	\$1,240.00
4.	3 Antennas	3 element yagi directional antenna	\$2.00/day rental	124 Day/Season	\$248.00
Total Equipment and Hardware Costs					---
Miscellaneous Costs (Out-of-Pocket):					
	Items	Cost/Unit	Units	Days	Cost
1.	Travel	0.445/mile	60mi/day	124 Days/Season	\$3,310.80
2.	Meals	---	\$40.00/Day (3 People)	124 Days/Season	\$4,960.00
3.	Mice to feed pine snakes (from Sept. 06 to Oct. 06; and April 07 to Oct. 07)	100 snakes in 06 52 snakes in 07	0.75 cents	35 days, 2006 100 days, 2007	\$300.00 \$1,200.00
4.	GIS Unit, Field Supplies, Phone, Fax, etc.	---	---	---	No Charge
Total Out-of-Pocket Costs					---
<b>Total Cost:</b>					<b>\$23,458.80</b>

**Table 3. The Direct and Indirect Costs of Labor and Salaries for three HA Staff Persons to Carry Out the Monitoring and Radio-Tracking Program in years 2006 and 2007.**

Task/Resource	Persons Involved	Hours	Hourly Rate	Total Cost	
<b>Yearly Radiotelemetric Study</b> (Every other day for 31 weeks, April 1-Nov. 1)					
1.	Project Management	Project Manager	8	\$100	\$800.00
2.	Office time for surgical transmitter implantation @ \$150.00 per snake for 35 adult pine snakes	Staff Herpetologist	---	---	\$5,250.00
3.	Radiotelemetry of 20 Snakes (8hrs/day for 124 days)	Staff Herpetologist	992	\$50	\$49,600.00
	Radiotelemetry of 15 Snakes (8hrs/day for 124 days)	Field Biologist	992	\$25	\$24,800.00
4.	Year-end Report Writing and Data Analysis	Staff Herpetologist	40	\$50	\$2,000.00
5.	Monitoring 52 Pine Snakes in Holding Pens	Field Biologist	384	\$25	\$9,600.00
Total direct Labor Cost (HA)					---
Profit Margin					---
<b>Total Cost Per Year:</b>					<b>\$101,255.00</b>
<b>Professional Discount:</b>					<b>-\$5,000.00</b>
<b>Cost 2007:</b>					<b>\$96,255.00</b>

The total estimated costs for start-up funding in 2006 and on-going monitoring and radio-tracking throughout 2007 is: Where \$23,458.80 is added with \$96,255.00 = **\$119,713.80**. The annual cost will go down in 2008 through 2013, as indicated below in the following Tables.

**Table 4. Material, Supplies, and Equipment Needed to Carry Out the Radio-Tracking and Monitoring Program in year 2008.**

Equipment and Hardware Cost Description					
		Items	Price	No. of units	Cost
1.	Radio-transmitters	Holohil SI-2 Transmitters	\$300.00	20	\$6,000.00
2.	Surgical Supplies	Anesthetic, sutures, scalpel blades, antiseptic, etc.	\$200.00	NA	\$200.00
3.	3 Radio Receivers	WMI TXR-200S radio receiver	\$10.00/day rental	124 Days/Season	\$1,240.00
4.	3 Antennas	3 element yagi directional antenna	\$2.00/day rental	124 Day/Season	\$248.00
Total Equipment and Hardware Costs					---
Miscellaneous Costs (Out-of-Pocket):		Cost/Unit	Units	Days	Cost
	Items				
1.	Travel	0.445/mile	60mi/day	124 Days/Season	\$3,310.80
2.	Meals	---	\$40.00/Day (3 People)	124 Days/Season	\$4,960.00
3.	GIS Unit, Field Supplies, Phone, Fax, etc.	---	---	---	No Charge
Total Out-of-Pocket Costs					---
<b>Total Cost:</b>					<b>\$15,958.80</b>

**Table 5. The Direct and Indirect Costs of Labor and Salaries to Carry Out the Radio-Tracking and Monitoring Program in year 2008.**

Task/Resource	Persons Involved	Hours	Hourly Rate	Total Cost	
<b>Yearly Radiotelemetric Study</b> (Every other day for 31 weeks, April 1-Nov. 1)					
1.	Project Management	Project Manager	8	\$100	\$800.00
2.	Office time for surgical transmitter implantation @ \$150.00 per snake for 35 adult pine snakes	Staff Herpetologist	----	---	\$5,250.00
3.	Radiotelemetry of 20 Snakes (8hrs/day for 124 days)	Staff Herpetologist	992	\$50	\$49,600.00
	Radiotelemetry of 15 Snakes (8hrs/day for 124 days)	Field Biologist	992	\$25	\$24,800.00
4.	Year-end Report Writing and Data Analysis	Staff Herpetologist	40	\$50	\$2,000.00
Total direct Labor Cost (HA)					---
Profit Margin					---
<b>Total Cost Per Year:</b>					<b>\$90,695.00</b>
<b>Professional Discount:</b>					<b>-\$5,000.00</b>
<b>Cost 2008:</b>					<b>\$85,695.00</b>

The total estimated costs for the on-going monitoring and radio-tracking throughout 2008 is: Where \$15,958.80 is added with \$85,695.00 = **\$101,653.80**.



**Table 6. Material, Supplies, and Equipment Needed to Carry Out the Monitoring and Radio-Tracking Program in 2009.**

Equipment and Hardware Cost Description					
		Items	Price	No. of units	Cost
1.	Radio-transmitters (Rebuilt by Manufacturer)	Holohil SI-2 Transmitters	\$200.00	10	\$2,000.00
2.	Surgical Supplies	Anesthetic, sutures, scalpel blades, antiseptic, etc.	\$200.00	NA	\$200.00
3.	3 Radio Receivers	WMI TXR-200S radio receiver	\$10.00/day rental	124 Days/Season	\$1,240.00
4.	3 Antennas	3 element yagi directional antenna	\$2.00/day rental	124 Day/Season	\$248.00
Total Equipment and Hardware Costs					\$3,688.00
Miscellaneous Costs (Out-of-Pocket):					
	Items	Cost/Unit	Units	Days	Cost
1.	Travel	0.445/mile	60mi/day	124 Days/Season	\$3,310.80
2.	Meals	---	\$40.00/Day (3 People)	124 Days/Season	\$4,960.00
3.	GIS Unit, Field Supplies, Phone, Fax, etc.	---	---	---	No Charge
Total Out-of-Pocket Costs					\$8,270.80
<b>Total Cost:</b>					<b>\$11,958.80</b>

**Table 7. The Direct and Indirect Costs of Labor and Salaries to Carry Out the Monitoring and Radio-Tracking Program in year 2009.**

Task/Resource	Persons Involved	Hours	Hourly Rate	Total Cost	
<b>Yearly Radiotelemetric Study</b> (Every other day for 31 weeks, April 1-Nov. 1)					
1.	Project Management	Project Manager	8	\$100	\$800.00
2.	Office time for surgical transmitter implantation @ \$150.00 per snake for 35 adult pine snakes	Staff Herpetologist	---	---	\$5,250.00
3.	Radiotelemetry of 20 Snakes (8hrs/day for 124 days)	Staff Herpetologist	992	\$50	\$49,600.00
	Radiotelemetry of 15 Snakes (8hrs/day for 124 days)	Field Biologist	992	\$25	\$24,800.00
4.	Year-end Report Writing and Data Analysis	Staff Herpetologist	40	\$50	\$2,000.00
Total direct Labor Cost (HA)					\$82,450.00
Profit Margin					10%
<b>Total Cost Per Year:</b>					<b>\$90,695.00</b>
<b>Professional Discount:</b>					<b>-\$5,000.00</b>
<b>Cost 2009:</b>					<b>\$85,695.00</b>

The total estimated costs for the on-going monitoring and radio-tracking throughout 2009 is: Where \$11,958.80 is added with \$85,695.00 = **\$97,653.80**.

**Table 8. Material, Supplies, and Equipment Needed to Carry Out the Monitoring and Radio-Tracking Program in 2010.**

Equipment and Hardware Cost Description					
		Items	Price	No. of units	Cost
1.	Radio-transmitters (Rebuilt by Manufacturer)	Holohil SI-2 Transmitters	\$200.00	10	\$2,000.00
2.	Surgical Supplies	Anesthetic, sutures, scalpel blades, antiseptic, etc.	\$200.00	NA	\$200.00
3.	3 Radio Receivers	WMI TXR-200S radio receiver	\$10.00/day rental	124 Days/Season	\$1,240.00
4.	3 Antennas	3 element yagi directional antenna	\$2.00/day rental	124 Day/Season	\$248.00
Total Equipment and Hardware Costs					---
<b>Miscellaneous Costs (Out-of-Pocket):</b>					
	Items	Cost/Unit	Units	Days	Cost
1.	Travel	0.445/mile	60mi/day	124 Days/Season	\$3,310.80
2.	Meals	---	\$40.00/Day (3 People)	124 Days/Season	\$4,960.00
3.	Field Supplies, Phone, Fax, etc.	---	---	---	No Charge
Total Out-of-Pocket Costs					---
<b>Total Cost:</b>					<b>\$11,958.80</b>

**Table 9. The Direct and Indirect Costs of Labor and Salaries to Carry Out the Monitoring and Radio-Tracking Program in year 2010.**

Task/Resource	Persons Involved	Hours	Hourly Rate	Total Cost	
<b>Yearly Radiotelemetric Study</b> (Every other day for 31 weeks, April 1-Nov. 1)					
1.	Project Management	Project Manager	8	\$100	\$800.00
2.	Office time for surgical transmitter implantation @ \$150.00 per snake for 35 adult pine snakes	Staff Herpetologist	---	---	\$5,250.00
3.	Radiotelemetry of 20 Snakes (8hrs/day for 124 days)	Staff Herpetologist	992	\$50	\$49,600.00
	Radiotelemetry of 15 Snakes (8hrs/day for 124 days)	Field Biologist	992	\$25	\$24,800.00
4.	Year-end Report Writing and Data Analysis	Staff Herpetologist	40	\$50	\$2,000.00
Total direct Labor Cost (HA)					---
Profit Margin					---
<b>Total Cost Per Year:</b>					<b>\$90,695.00</b>
<b>Professional Discount:</b>					<b>-\$5,000.00</b>
<b>Cost 2010:</b>					<b>\$85,695.00</b>

The total estimated costs for the on-going monitoring and radio-tracking throughout 2010 is: Where \$11,958.80 is added with \$85,695.00 = **\$97,653.80**.

**Table 10. Material, Supplies, and Equipment Needed to Carry Out the Monitoring and Radio-Tracking Program in 2011.**

Equipment and Hardware Cost Description					
		Items	Price	No. of units	Cost
1.	Radio-transmitters (Rebuilt by Manufacturer)	Holohil SI-2 Transmitters	\$200.00	10	\$2,000.00
2.	Surgical Supplies	Anesthetic, sutures, scalpel blades, antiseptic, etc.	\$200.00	NA	\$200.00
3.	3 Radio Receivers	WMI TXR-200S radio receiver	\$10.00/day rental	124 Days/Season	\$1,240.00
4.	3 Antennas	3 element yagi directional antenna	\$2.00/day rental	124 Day/Season	\$248.00
Total Equipment and Hardware Costs					\$3,688.00
Miscellaneous Costs (Out-of-Pocket):					
	Items	Cost/Unit	Units	Days	Cost
1.	Travel	0.445/mile	60mi/day	124 Days/Season	\$3,310.80
2.	Meals	---	\$40.00/Day (3 People)	124 Days/Season	\$4,960.00
3.	Field Supplies, Phone, Fax, etc.	---	---	---	No Charge
Total Out-of-Pocket Costs					\$8,270.80
<b>Total Cost:</b>					<b>\$11,958.80</b>

**Table 11. The Direct and Indirect Costs of Labor and Salaries to Carry Out the Monitoring and Radio-Tracking Program in year 2011.**

Task/Resource		Persons Involved	Hours	Hourly Rate	Total Cost
<b>Yearly Radiotelemetric Study</b> (Every other day for 31 weeks, April 1-Nov. 1)					
1.	Project Management	Project Manager	8	\$100	\$800.00
2.	Office time for surgical transmitter implantation @ \$150.00 per snake for 35 adult pine snakes	Staff Herpetologist	---	---	\$5,250.00
3.	Radiotelemetry of 20 Snakes (8hrs/day for 124 days)	Staff Herpetologist	992	\$50	\$49,600.00
	Radiotelemetry of 15 Snakes (8hrs/day for 124 days)	Field Biologist	992	\$25	\$24,800.00
4.	Year-end Report Writing and Data Analysis	Staff Herpetologist	40	\$50	\$2,000.00
Total direct Labor Cost (HA)					\$82,450.00
Profit Margin					10%
<b>Total Cost Per Year:</b>					<b>\$90,695.00</b>
<b>Professional Discount:</b>					<b>-\$5,000.00</b>
<b>Cost 2011:</b>					<b>\$85,695.00</b>

The total estimated costs for the on-going monitoring and radio-tracking throughout 2011 is: Where \$11,958.80 is added with \$85,695.00 = **\$97,653.80**.

**Table 12. Material, Supplies, and Equipment Needed to Carry Out the Radio-Tracking Program in year 2012.**

Equipment and Hardware Cost Description					
		Items	Price	No. of units	Cost
1.	Radio-transmitters (Rebuilt by Manufacturer)	Holohil SI-2 Transmitters	\$200.00	10	\$2,000.00
2.	Surgical Supplies	Anesthetic, sutures, scalpel blades, antiseptic, etc.	\$200.00	NA	\$200.00
3.	3 Radio Receivers	WMI TXR-200S radio receiver	\$10.00/day rental	124 Days/Season	\$1,240.00
4.	3 Antennas	3 element yagi directional antenna	\$2.00/day rental	124 Day/Season	\$248.00
Total Equipment and Hardware Costs					\$3,688.00
Miscellaneous Costs (Out-of-Pocket):					
	Items	Cost/Unit	Units	Days	Cost
1.	Travel	0.445/mile	60mi/day	124 Days/Season	\$3,310.80
2.	Meals	---	\$40.00/Day (3 People)	124 Days/Season	\$4,960.00
3.	GIS Unit, Field Supplies, Phone, Fax, etc.	---	---	---	No Charge
Total Out-of-Pocket Costs					\$8,270.80
<b>Total Cost:</b>					<b>\$11,958.80</b>

**Table 13. The Direct and Indirect Costs of Labor and Salaries to Carry Out the Radio-Tracking Program in year 2012.**

Task/Resource		Persons Involved	Hours	Hourly Rate	Total Cost
<b>Yearly Radiotelemetric Study</b> (Every other day for 31 weeks, April 1-Nov. 1)					
1.	Project Management	Project Manager	8	\$100	\$800.00
2.	Office time for surgical transmitter implantation @ \$150.00 per snake for 35 adult pine snakes	Staff Herpetologist	---	---	\$5,250.00
3.	Radiotelemetry of 20 Snakes (8hrs/day for 124 days)	Staff Herpetologist	992	\$50	\$49,600.00
	Radiotelemetry of 15 Snakes (8hrs/day for 124 days)	Field Biologist	992	\$25	\$24,800.00
4.	Year-end Report Writing and Data Analysis	Staff Herpetologist	40	\$50	\$2,000.00
Total direct Labor Cost (HA)					\$82,450.00
Profit Margin					10%
<b>Total Cost Per Year:</b>					<b>\$90,695.00</b>
<b>Professional Discount:</b>					<b>-\$5,000.00</b>
<b>Cost 2012:</b>					<b>\$85,695.00</b>

The total estimated costs for the on-going monitoring and radio-tracking throughout 2012 is: Where \$11,958.80 is added with \$85,695.00 = **\$97,653.80**.

**Table 14. Material, Supplies, and Equipment Needed to Carry Out the Monitoring and Radio-Tracking Program in year 2013.**

Equipment and Hardware Cost Description					
		Items	Price	No. of units	Cost
1.	Radio-transmitters (Rebuilt by Manufacturer)	Holohil SI-2 Transmitters	\$200.00	10	\$2,000.00
2.	Surgical Supplies	Anesthetic, sutures, scalpel blades, antiseptic, etc.	\$200.00	NA	\$200.00
3.	3 Radio Receivers	WMI TXR-200S radio receiver	\$10.00/day rental	60 Days/Season	\$600.00
4.	3 Antennas	3 element yagi directional antenna	\$2.00/day rental	60 Day/Season	\$120.00
Total Equipment and Hardware Costs					\$2,920.00
Miscellaneous Costs (Out-of-Pocket):					
	Items	Cost/Unit	Units	Days	Cost
1.	Travel	0.445/mile	60mi/day	60 Days/Season	\$1,602.00
2.	Meals	---	\$40.00/Day (3 People)	60 Days/Season	\$2,400.00
3.	GIS Unit, Field Supplies, Phone, Fax, etc.	---	---	---	No Charge
Total Out-of-Pocket Costs					\$4,002.00
<b>Total Cost:</b>					<b>\$6,922.00</b>

**Table 15. The Direct and Indirect Costs of Labor and Salaries to Carry Out the Radio-Tracking Program and Final Report Writing in year 2013.**

Task/Resource	Persons Involved	Hours	Hourly Rate	Total Cost	
<b>Yearly Radiotelemetric Study</b> (Every other day for 15 weeks, April 1-July 15)					
1.	Project Management	Project Manager	8	\$100	\$800.00
2.	Office time for surgical transmitter implantation @ \$150.00 per snake for 35 adult pine snakes	Staff Herpetologist	---	---	\$5,250.00
3.	Radiotelemetry of 20 Snakes (8hrs/day for 60 days)	Staff Herpetologist	480	\$50	\$24,000.00
	Radiotelemetry of 15 Snakes (8hrs/day for 60 days)	Field Biologist	480	\$25	12,000.00
4.	Year-end Report Writing and Data Analysis	Staff Herpetologist	40	\$50	\$2,000.00
Total direct Labor Cost (HA)					\$44,050.00
Profit Margin					\$4,405.00
<b>Total Cost Per Year:</b>					<b>\$48,455.00</b>
<b>Professional Discount:</b>					<b>-\$5,000.00</b>
<b>Cost 2013:</b>					<b>\$43,455.00</b>

The total estimated costs for the final year of monitoring and radio-tracking in 2013 is: Where \$6,922.00 is added with \$43,455.00 = **\$50,377.00**.



**Table 16. Budget and payment schedule for funding to be received by the New Jersey Department of Environmental Protection for labor costs associated with the Division of Fish and Wildlife’s role in this management plan.**

<b>Year</b>	<b>Payment Date</b>	<b>Payment Amount</b>
Year 1	Upon Plan Approval	\$17,250.00
Year 2	July 1, 2008	\$15,000.00
Year 3	July 1, 2009	\$15,000.00
Year 4	July 1, 2010	\$20,000.00
Year 5	July 1, 2011	\$20,000.00
Year 6	July 1, 2012	\$20,000.00
Year 7	July 1, 2013	\$20,000.00



**NORTHERN PINE SNAKE BIBLIOGRAPHY, LITERATURE CITED,  
and R. T. ZAPPALORTI'S PUBLICATIONS**

---

---

- Arnold, S. J. 1993. Foraging theory and prey-size – predator size relations in snakes. In R. A. Seigel and J. T. Collins (eds.), Snakes: Ecology and Behavior. McGraw-Hill, Inc., New York, New York. pp. 87-115.
- Ashton, R., E., Jr., and P. S. Ashton. 1998. Florida pine snake, king snake, and corn snake. In R. E. Ashton, Jr. and P. S. Ashton (eds.), Handbook of Reptiles and Amphibians of Florida. Part I: The Snakes. Second edition. Windward Publishers, Inc., Miami, Florida. pp. 163-164.
- Babis, W.A. 1949. Notes on the food of the indigo snake. *Copeia* 1949 (2):147.
- Bogert, C.M. and R. B. Cowels. 1947. Results of the Archibold expeditions. No. 58. Moisture loss in relation to habitat selection in some Floridian reptiles. Amer. Mus. Novitates 1358: 1-34.
- Bailey, M.A., J.N. Holmes, K.A. Buhlmann, and J.C. Mitchell. 2006. Habitat Management Guidelines for Amphibians and Reptiles of Southeastern United States. Partners in Amphibian and Reptile Conservation Technical Publication HMG-2, Montgomery, Alabama. 88pp.
- Brown, W. S. 1993. Biology, status, and management of the timber rattlesnake (*Crotalus horridus*): a guide for conservation. SSAR Herpetological Circ. No. 22, Lawrence, Kansas. 78 pp.
- Brown, W. S., D. W. Pyle, K. R. Greene, and J. B. Friedlaender. 1982. Movements and temperature relationships of timber rattlesnakes (*Crotalus horridus*) in northeastern New York. Journal of Herpetology. 16:151-161.
- Burghardt, G.M. 1997. Learning Processes in Reptiles. In: Biology of the Reptilia. Vol.7, Eds. C. Gans and D. Tinkle. Academic Press, New York. pp. 555-681.
- Burghardt, G.M. and Greene, H. W. 1988. Predator simulation and duration of death feigning in neonate hognose snakes. Animal Behavior 36 (1988). pp. 1842-1843.
- Burger, J. and R. T. Zappalorti. 1986. Nest Site Selection by Pine Snakes (*Pituophis melanoleucus*) in the New Jersey Pine Barrens. Copeia, (No. 1):116-121.
- Burger, J. and R. T. Zappalorti. 1988. Habitat Use in Free-ranging Pine Snakes (*Pituophis melanoleucus*) in the New Jersey Pine Barrens. Herpetologica 44(1):48-55.
- Burger, J. and R. T. Zappalorti. 1989. Habitat Use by Pine Snakes (*Pituophis melanoleucus*) in the New Jersey Pine Barrens: Individual and Sexual Variation. *Journal of Herpetology*, 23(1):68-73.
- Burger, J. and R. T. Zappalorti. 1991. Nesting Behavior of Pine Snakes (*Pituophis melanoleucus*) in the New Jersey Pine Barrens. Journal of Herpetology 25(2):152-160.

- Burger, J. and R. T. Zappalorti. 1992. Philopatry and nesting phenology of pine snakes (*Pituophis melanoleucus*) in the New Jersey Pine Barrens. Behavioral Ecology and Sociobiology. Springer - Verlag (1992) 30:331-336.
- Burger, J., R. T. Zappalorti, and M. Gochfeld. 2000. Defensive behaviors of pine snakes (*Pituophis melanoleucus*) and black racers (*Coluber constrictor*) to disturbance during hibernation. Herpetological Natural History, 7(1), 1999-2000, pages 59-66.
- Burger, J. and R. T. Zappalorti, J. Dowdell, T. Georgiadis, J. Hill, and M. Gochfeld. 1992. Subterranean Predation on Pine Snakes (*Pituophis melanoleucus*). Journal of Herpetology, Vol. 26, No. 3, pp. 259-263, 1992.
- Burger, J., R. T. Zappalorti, M. Gochfeld, W. Boarman, M. Caffrey, V. Doig, S. Garber, B. Lauro, M. Mikovsky, C. Safina, and J. Saliva.. 1988. Hibernacula and Summer Den Sites of Pine Snakes (*Pituophis melanoleucus*) in the New Jersey Pine Barrens. Journal of Herpetology 22(4):425-433.
- Campbell, H. W. and S.P. Christman. 1982. Field techniques for herpetofaunal community analysis in herpetological communities. Ed. by Norman J. Scott, Jr., U.S. Dept. of the Interior, Fish and Wildlife Service. Wildlife Research Report No. 13, pp. 193-200.
- Carr, A. E., Jr. 1952. Handbook of Turtles. Cornell University Press, Ithaca and London. 542 pp.
- Carpenter, C. C. 1953. A study of hibernacula and hibernating associations of snakes and amphibians in Michigan. Ecology 34: 74-80.
- Carpenter, C. C. 1957. Hibernation, hibernacula, and associated behavior of the three-toed box turtle (*Terrapene carolina triunguis*). Copeia. 4: 278-282.
- Carpenter, C. 1982. The Bullsnake as an Excavator. Journal of Herpetology. 16(4):394-401.
- Carson, H.L. 1945. Delayed fertilization in a captive indigo snake with note of feeding and shedding. Copeia 1945(4):222-224.
- Clark, D. R., Jr. 1971. Branding as a marking technique for amphibians and reptiles. Copeia 1:148-151.
- Conant, R. 1975. A field guide to reptiles and amphibians of eastern and central North America. Second edition. Houghton Mifflin Co.; Boston, Mass. 429 pp.
- Conant, R. and J. T. Collins. 1991. A Field Guide to Reptiles and Amphibians: Eastern and Central North America. Houghton Mifflin Co., Boston. 450 pp.
- Casazza, M. L. and G.D. Wylie. 1999. Use of implanted motion sensitive transmitters with remote data loggers to measure activity patterns in giant garter snakes. U.S. Geological Survey. Biological Resources Division, California Science Center, Dixon Field Station. Northern Prairie Wildlife Research Center. <http://www.npwrc.usgs.gov/resource/tools/telemetry/motion.htm>
- Casazza, M.L., G.D. Wylie, and C.J. Gregory. 2000. A funnel trap modification for surface collection of aquatic amphibians and reptiles. Herpetol. Rev. 31:91-92.

- Cavitt, J. F. 2000. Fire and tallgrass prairie reptile community: effects on relative abundance and seasonal activity. *Journal of Herpetology*. 34:12-20.
- Dalrymple, G. H. 1988. The herpetofauna of Long Pine Key, Everglades National Park, in relation to vegetation and hydrology. *In* R. C. Szaro, K.E. Severson, and D. R. Patton (tech. coords.), *Management of Amphibians, Reptiles, and Small Mammals in North America*, pp. 72-86. USDA Forest Service, Gen. Tech. Rept. RM-166, Fort Collins, CO.
- Dargan, L. M., and W. H. Stickel. 1949. An experiment with snake trapping. *Copeia* 1949:264-268.
- Diemer, J. E. and D. W. Speake. 1981. The status of the eastern indigo snake in Georgia. *In*: R. Odum and J. Guthrie, eds. *Proc. Nongame and End. Wildl. Symp.*, GA Dept. Nat. Res. Game and Fish Div., Tech. Bull. WL 5, Pp. 52-61.
- Diemer, J. E. and D. W. Speake. 1983. The distribution of the eastern indigo snake, *Drymarchon corais couperi*, in Georgia. *J. Herpetology* 17(3): 256-264.
- Dodd, Jr., C. K. 1993. Strategies for snake conservation. *In* *Snakes: Ecology and Behavior*. McGraw-Hill, Inc. New York, New York. Chapter 6, pg. 214.
- Dodd, Jr., C. K., and R. Franz. 1995. Seasonal abundance and habitat use of selected snakes trapped in xeric and mesic communities of central Florida. *Bulletin of the Florida State Museum of Natural History*. 38, Pt. 1(2): 43-67 pp.
- Domjan, M. 1996. *The Essentials of Conditioning and Learning*. 116-129. California: Brooks/Cole Publishing Company. pp. 23-52.
- Enge, K. M. 1997. A standardized protocol for drift fence surveys. Technical Report No. 14. Florida Game and Fresh Water Fish Commission, Tallahassee, Florida. 68 pp.
- Enge, K. M. 1997b. Use of silt fencing and funnel traps for drift fencing. *Herpetol. Rev.* 28:30-31.
- Enge, K. M. 1998a. Herpetofaunal drift-fence survey of steephead ravines in 2 river drainages. *Proc. SE Assoc. Fish Wildlife Agencies* 52:336-348.
- Enge, K. M. 1998b. Herpetofaunal survey of an upland hardwood forest in Gadsden County, Florida. *Fla. Sci.* 61:141-159.
- Enge, K. M. 2001. The pitfalls of pitfall trapping. *Journal of Herpetology*. 35(3):467-478.
- Enge, K. M. and W.R. Marion. 1986. Effects of clear cutting and site preparation on herpetofauna of a north Florida flatwoods. *For. Ecol. Manage.* 12:177-192.
- Enge, K. M. and K. N. Wood. 1998. Herpetofaunal surveys of the Big Bend Wildlife Management Area, Taylor County, Florida. *Fla. Sci.* 61:62-87.
- Enge, K. M. and K. N. Wood. 1999-2000. A herpetofaunal survey of Chassahowitzka Wildlife Management Area, Hernando County, Florida. *Herpetol. Nat. Hist.* 7:117-144.



- Ernst, C. H., J. E. Lovich and R.W. Barbour. 1994. Turtles of the United States and Canada. Smithsonian Institution Press, Washington and London. 578 pp.
- Ernst, C. H., R. T. Zappalorti, and J. E. Lovich. 1989. Overwintering sites and thermal relations of hibernating bog turtles, *Clemmys muhlenbergii*. *Copeia* 1989(3), pg. 761-764.
- Ernst, C.H., J. E. Lovich, R. T. Zappalorti, and Herman, D. W. 1996. Geographic Variation in Growth and Sexual Size Dimorphism of Bog Turtles (*Clemmys muhlenbergii*). *American Midland Naturalist*.
- Ford, N.B. and Burghardt, G.M. 1993. Perceptual Mechanisms and the Behavioral Ecology of Snakes. In: Snakes: Ecology and Behavior. Eds. Seigel, R.A. & Collins, J. T. pp. 117-164.
- Fitch, H. S. 1949. Road counts of snakes in western Louisiana. *Herpetologica* 5: 87-90.
- Fitch, H.S. 1982. Resources of a snake community in prairie-woodland habitat of northeastern Kansas. In N.J. Scott Jr. (ed.), *Herpetological Communities*, pg. 83-97. Wildlife. Res. Report 13, U.S. Fish and Wildlife. Service., Washington, DC.
- Fitch, H.S. 1999. A Kansas Snake Community: Composition and Changes over 50 years. Krieger Publishing Company. Malabar, Florida. 105 pp.
- Fitch, H. S., and H. W. Shirer. 1971. A radio telemetric study of spatial relationships in some common snakes. *Copeia* 1971:118-128.
- Fukada, H. 1978. Growth and Maturity of the Japanese Rat Snake (*Elaphe climacophora*), *Journal of Herpetology* 12 (3): 269-274.
- Fukada, H. 1960. Biological Studies on the Snakes. Reprinted from the Bulletin of the Kyoto Gakugei University. Ser. B: No. 16, March.
- Frier, J. and R. T. Zappalorti. 1983. Reptile and amphibian management techniques. *Transactions of the North American Wildlife Society*, 40:142-148.
- Gerald, G.W., M.A. Bailey, and J.N. Holmes. 2006. Habitat Utilization of *Pituophis m. melanoleucus* (Northern Pinesnake) on Arnold Air Force Base in Middle Tennessee. *Southeast Naturalist* 5(2):253-264.
- Gibbons, J. W. 1972. Reproduction, growth, and sexual dimorphism in the canebrake rattlesnake (*Crotalus horridus atricaudatus*). *Copeia* 1972:222-226.
- Gillingham, C. and C. Carpenter. 1978. Snake Hibernation: Construction of and Observations on a Man-made Hibernaculum (Reptilia, Serpentes). *Journal of Herpetology*, 1978 12(4):495-498.
- Gillingham, C. 1987. Social Behavior in Snakes. Section 3 - Life History and Ecology. In: Snakes, Ecology and Evolutionary Biology. Eds. R. A. Seigel, J. T. Collins, and S. S. Novak. Macmillan Publishing Company, New York. Pp. 184-200.

- Gregory, P. T. 1974. Patterns of spring emergence of the red-sided garter snake (*Thamnophis sirtalis parietalis*) in the Interlake region of Manitoba. *Canadian Journal of Zoology* 52: 1063-1068.
- Gregory, P. T., J. M. McCartney, and K. W. Larsen. 1987. Spatial patterns and movements. P. 336 – 395. In: *Snakes: ecology and evolutionary biology*. R. A. Seigel, J. T. Collins, and S. S. Novak (Eds.). McMillian Publishing Co. New York, New York.
- Greene, H. W. 1988. Antipredator Mechanisms in Reptiles. In: *Biology of the Reptilia*. Vol. 16, Eds. C. Gans and R. B. Huey. Alan Liss, New York. pp. 1-152.
- Groves, F. 1960. [The eggs and young of \*Drymarchon corais couperi\*](#). *Copeia* 1960(1):51-53.
- Henderson, R. W. 1974. Resource partitioning among the snakes of the University of Kansas Natural History Reservation: a preliminary analysis. Milwaukee Public. Museum. Publ. Biol. Geol. 1:1-11.
- Himes, J.G. 2001. [Burrowing ecology of the rare and elusive Louisiana pine snake, \*Pituophis ruthveni\* \(Serpentes: Colubridae\)](#). *Amphibia-Reptilia*, Brill Academic Publishers. Volume 22, Number 1, 2001, pp. 91-101.
- Himes, J. G., L. M. Hardy, D.C. Rudolph and S.J. Burgdorf. 2006. [Body temperature variations of the Louisiana Pine Snake \(\*Pituophis ruthveni\*\) in a longleaf pine ecosystem](#). *Herpetological Natural History*. 9 (2): 117-126.
- Himes, J.G., L.M. Hardy, D.C. Rudolph and S.J. Burgdorf. 2006. Movement patterns and habitat selection by native and repatriated Louisiana Pine Snakes (*Pituophis ruthveni*): Implications for conservation. *Herpetological Natural History*. 9 (2): 103-116.
- Hipes, D. L., D. R. Jackson, K. NeSmith, D. Printiss, and K. Brandt. 2001. Field guide to the rare animals of Florida. Florida Natural Areas Inventory, Tallahassee, Florida.
- Hulmes, D., P. Hulmes, and R. Zappalorti. 1981. Notes on the ecology and distribution of the Pine Barrens treefrog, *Hyla andersonii*, in New Jersey. *Bull. New York Herp. Soc.*, 17(1).
- Holtzman, D. 1998. Spatial learning of an escape task by hatchling corn snakes (*Elaphe guttata*). *Animal Behavior*, January Vol. 51(1) 1998.
- Hooge, P. N., W. Eichenlaub, and E. Solomon. 1999. [The animal movement program](#). USGS, Alaska Biological Science Center.
- Hyslop, N. L., J. M. Meyers, and R. J. Cooper. 2005. Seasonal variations in home range and refuge use of the threatened eastern indigo snake (*Drymarchon couperi*) in southeastern Georgia. Abstract. 27<sup>th</sup> Annual Meeting of the Gopher Tortoise Council, Palatka, Florida, October 7 to 9, 2005. p10.
- James, F. C., and H. H. Sugart, Jr. 1970. A quantitative method of habitat description. *Audubon Field Notes* 24:727-736.
- Jennrich, R.I. and F.B. Turner. 1969. [Measurement of non-circular home range](#). *Journal of Theoretical Biology* 22:227-237.



- Karns, D. R. 1986. Field herpetology methods for the study of amphibians and reptiles in Minnesota. Published in cooperation with the Nongame Wildlife Program of the Minnesota Dept. of Natural Resources. James Ford Bell Museum of Natural History, Univ. of Minnesota, Occasional Paper No. 18.
- Kauffeld, C. F. 1957. Snakes and Snake Hunting. Hanover House, Garden City, New York. P. 266.
- Kauffeld, C.F. 1969. Snakes: The Keeper and the Kept. Doubleday & Co., Garden City, N.Y. P. 168.
- Keegan, H.L. 1944. Indigo snakes feeding upon poisonous snakes. *Copeia* 1944(1):59.
- Kernohan, B. J., R. A. Gitzen, and J. J. Millspaugh. 2001. Chapter 5: Analysis of animal space use and movements. J. J. Millspaugh and J. M. Marzluff (editors), *Radio Tracking and Animal Populations*. Academic Press, New York, New York. pp. 125-166
- Kingsbury, B. and J. Gibson, 2002. Habitat management guidelines for amphibians and reptiles of the Midwest. A publication of Partners in Amphibian and Reptile Conservation (PARC). P. 57.
- Kochman, H.I. 1978. Eastern indigo snake (*Drymarchon corais couperi*). Pp. 68-69. In: R.W. McDiarmid, ed. Rare and Endangered biota of Florida.
- Krysko, K. L., and R. Franz. 2003. Systematics and conservation of the kingsnake (*Lampropeltis getula*) in Florida. Final Report. Fish and Wildlife Conservation Commission. Tallahassee, Florida, USA. Pp.49.
- Landers, J. L. and D. W. Speake. 1980. Management needs of sandhill reptiles in southern Georgia. Proc. Ann. Conf. S. E. Assoc. Fish and Wildlife Agencies. 34:515-529.
- Lawler, H.E. 1977. The status of *Drymarchon corais couperi* (Holbrook), the eastern indigo snake, in the southeastern U.S.A. *Herpetological Review*. 8(3):76-79.
- Lutterschmidt, W. I. 1994. The effect of surgically implanted radio-transmitters upon the locomotory performance of the checkered garter snake, *Thamnophis m. marcianus*. *Journal of Herpetology*. 4:11-14.
- Martof, B. S. 1968. *Ambystoma cingulatum* (Cope). Flatwoods salamander. *Cat. Am. Amphibians and Reptiles* 57:1-2.
- McCranie, J. R. 1980. *Drymarchon corais*. *Cat. Amer. Amphibians and Reptiles*. 267. 1-267. 4.
- Means, D. B. 1978. Rare: Apalachicola populations of the eastern common kingsnake including *L. g. goini*, *Lampropeltis getulus* (Linnaeus). Pages 60-61 in R. W. McDiarmid, ed. Rare and endangered biota of Florida. Volume three: amphibians and reptiles. Univ. Presses Florida, Gainesville.
- Moler, P. E. 1982. Indigo snake habitat determination. Florida Game and Fresh Water Fish Comm., Wildlife Research Laboratory, Gainesville. 17pp. (Unpublished. rep.)

- Moler, P. E. 1985. Distribution of the eastern indigo snake, *Drymarchon corais couperi*, in Florida. *Herpetological Review*. 16:37-38.
- Moler, P. E., and R. Franz. 1988. Wildlife values of small, isolated wetlands in the southeastern coastal plain. R. R. Odum, K. A. Riddleberger, and J. C. Ozier, eds. *Proc. Southeast Nongame and Endangered Wildlife. Symp.* 3:234-241, Ga. Dep. Nat. Resources., Game and Fish Division.
- Moler, P. E. (ed.) 1992. *Rare and endangered biota of Florida, vol. III: Amphibians and reptiles*. University Press of Florida, Gainesville.
- Moulis, R. 1976. Autecology of the eastern indigo snake *Drymarchon corais couperi*. *Bull. New York Herpetol. Soc.* 12(3-4): 14-23.
- Morgan, B. J. 1987. The last of the kingsnakes. *Gainesville Herpetological Society Newsletter*. 4(4):3-4.
- Mushinsky, H. R., and E. D. McCoy. 1991. Vertebrate species composition of selected scrub islands on the Lake Wales Ridge of central Florida. Fla. Game and Fresh Water Fish Comm., Nongame Wildlife Program, Final Report, NG87-149. 325pp.
- Quinn, H. and J.P. Jones. 1974. Squeeze box technique for measuring snakes. *Herp. Rev.* 5:32.
- Radford, A. E., H.E. Ahles and C.R. Bell. 1968. *Manual of the Vascular Plant Species of the Carolinas*. The University of North Carolina Press, Chapel Hill. 1833 pp.
- Reichling, S. 2005. Pine snakes, pocket gophers, and partnerships. *Communique*. Publication of the American Zoo and Aquarium Association. May 2005. pp. 6-9.
- Reinert, H. K. 1984a. [Habitat variation between sympatric snake populations. Ecology 65:478-486.](#)
- Reinert, H. K. 1984b. [Habitat variation within sympatric snake populations. Ecology 65:1673-1682.](#)
- Reinert, H. K. 1992. Radiotelemetric field studies of pit vipers: Data acquisition and analysis. In J. A. Campbell and E.D. Brodie, eds. *Biology of the Pitvipers*, Selva Press, Tyler, Texas., pp. 185-197.
- Reinert, H. K. 1994. Habitat selection in snakes. (In) R. A. Seigel and J. T. Collins (eds.), *Snakes: Ecology and Behavior*, McGraw-Hill, New York. pp. 201-240.
- Reinert, H. K. and D. Cundall. 1982. [An improved surgical implantation method for radio-tracking snakes. Copeia 1982:702-705.](#)
- Reinert, H. K. and R. T. Zappalorti. 1988a. [Timber rattlesnakes \(\*Crotalus horridus\*\) of the Pine Barrens: their movement patterns and habitat preference. Copeia 1988:964-978.](#)
- Reinert, H. K. and R. T. Zappalorti. 1988b. [Field observation of the association of adult and neonatal timber rattlesnakes, \*Crotalus horridus\*, with possible evidence for conspecific trailing. Copeia 1988:1056-1059.](#)

- Reinert, H. K., and R. R. Rupert, Jr. 1999. Impacts of relocation on behavior and survival of timber rattlesnakes, *Crotalus horridus*. *Journal of Herpetology*. 33:45-61.
- Reynolds, R. P. and N.J. Scott, Jr. 1982. Use of a Mammalian Resource by A Chihuahuan Snake Community. In: *Herpetological Communities*, edited by Norman J. Scott, Jr., U.S. Dept. of the Interior, Fish and Wildlife Service, Wildlife Research Report #13, pp. 99-118.
- Rudolph, C., and S. J. Burgdorf. 1997. Timber rattlesnakes and Louisiana pine snakes of the west Gulf Coastal Plain: hypotheses of decline. *Texas J. Science*. 49 Supplements:111-122.
- Rudolph, C., S. J. Burgdorf, R. N. Conner, and J. G. Dickson. 1998. The impacts of roads on the timber rattlesnake, (*Crotalus horridus*), in eastern Texas. *Proceedings of an International Conference on Wildlife Ecology*. Transportation, Ft. Myers, Florida. pp. 236-240.
- Rudolph, C., S. J. Burgdorf, R. R. Schaefer, R. N. Conner, and R. T. Zappalorti. 1998. Snake mortality associated with late season radio-transmitter implantation. *Herpetological Rev.* 29:155-156.
- Rudolph, D. C., S. J. Burgdorf, R. N. Conner, C. S. Collins, D. Saenz, R. R. Schaefer, T. Trees, C. M. Duran, M. Ealy and J. G. Himes. 2002 (2003). Prey handling and diet of Louisiana Pine Snakes (*Pituophis ruthveni*) and Black Pine Snakes (*P. melanoleucus lodingi*), with comparisons to other selected colubrid snakes. *Herpetological Natural History*. 9(1):57-62.
- Savannah River Ecology Laboratory (SREL) Outreach Program. 2001. Pit tag fact sheet, <http://www.uga.edu/~srel/pittag.htm>.
- Schaefer, W. H. 1934. Diagnosis of sex in snakes. *Copeia* 1934:181.
- Seaman, D. E., and R. A. Powell. 1996. An evaluation of the accuracy of kernel density estimators for home range analysis. *Ecology* 77: 2075-2085.
- Shaw, C.E. 1959. Longevity of snakes in the United States as of January 1, 1959. *Copeia* (4):336-337.
- Southwood, T.R.E. 1966. *Ecological Methods*. Methuen and Co., London, England.
- Speake, D. W. and J. A. McGlincy. 1981. Response of indigo snakes to gassing of their dens. *Proc. Ann. Conf. S. E. Assoc. Fish and Wildl. Agencies*. 35:135-138.
- Speake, D. W., J. A. McGlincy, and T. R. Colvin. 1978. Ecology and management of the eastern indigo snake in Georgia: A progress report. Pp 64-73, In: R.R. Odum and L. Landers, eds. *Proc. Rare and End. Wildl. Symp.*, Georgia Dept. Nat. Res., Game and Fish Div., Tech. Bull. WL 4.
- Speake, D. W. and R.H. Mount. 1973. Some possible ecological effects of "rattlesnake roundups" in the southeastern coastal plain. *Proc. Ann. Conf. S. E. Assoc. Fish and Wildl. Agencies*. 27: 267-277.
- Steiner, T.M., O. L. Bass, Jr., and J. A. Kushlan. 1983. Status of the eastern indigo snake in southern Florida National Parks and vicinity. *S. FL. Res. Ctr. Rept. SFRC-83/01*. 25 pp. (Everglades National Park, Homestead, FL).

- Steiner, T.M., O. L. Bass, Jr., and J. A. Kushlan. 1983. Status of the eastern indigo snake in southern Florida National Parks and vicinity. S. FL. Res. Ctr. Rept. SFRC-83/01. 25 pp. (Everglades National Park, Homestead, FL).
- Stevenson, Dirk J., Dyer, Karen J., Willis-Stevenson, Beth A. 2003. Survey and Monitoring of the Eastern Indigo Snake in Georgia. Southeastern Naturalist Volume: 2. Pages: 393-408.
- Stuart, J. N., M. L. Watson, T. L. Brown, and C. Eustice. 2001. Plastic Netting: An Entanglement Hazard to Snakes and Other Wildlife. Herpetological Review 32(3), Pp 162-163.
- Tiebout, H. M., and J. R. Carey. 1987. Dynamic spatial ecology of the water snake (*Nerodia sipedon*). Copeia 1997:1-18.
- Timmerman, W. W. 1989. Home range, habitat use and behavior of the eastern diamondback rattlesnake. M.S. Thesis, Univ. Florida, Gainesville. 80pp.
- Timmerman, W. W. 1990. Radio-telemetry of the eastern diamondback rattlesnake in north Florida sandhills - a preliminary report. Proceedings of the Annual Meeting of the Gopher Tortoise Council. 8:22-26.
- Towson, S. 1978. Notes on the status, care, and breeding of the eastern indigo snake, *Drymarchon corais couperi*. Br. Herpetological. Soc. Newsletter. (19):9-12.
- Tuberville, T. D., E. E. Clark, K. A. Buhlmann, and J. W. Gibbons. 2005. Translocation as a conservation tool: site fidelity and movement of repatriated gopher tortoises (*Gopherus polyphemus*). Animal Conservation. (8):1-10.
- U.S. Fish and Wildlife Service. 1982. Eastern Indigo Snake Recovery Plan. U.S. Fish and Wildlife Service. Atlanta, GA.
- Weatherhead, P. J., and F. W. Anderka. 1984. An improved radio transmitter and implantation technique for snakes. Journal of Herpetology. 18:264-269.
- Wright, A.H. and A.A. Wright. 1957. Handbook of snakes of the United States and Canada. Comstock Pub. Ithaca, NY. 1105 pp. 25 U.S. Fish and Wildlife Service. 1982. Eastern Indigo Snake Recovery Plan. U.S. Fish and Wildlife Service. Atlanta, GA. 23 pp.
- Zappalorti, R. T. 1976. The Amateur Zoologist's Guide to Turtles and Crocodilians. Harrisburg, Pa., Stackpole Books. pp. 122-139.
- Zappalorti, R. T. and H. K. Reinert. 1988. Revised final report on habitat utilization by the timber rattlesnake, *Crotalus horridus* (Linnaeus) in southern New Jersey with notes on hibernation. Unpublished Report to New Jersey Dept. of Environmental Protection, Division of Fish, Game, and Wildlife, Trenton, New Jersey. 128 p.
- Zappalorti, R. T. and H. K. Reinert. 1994. Artificial refugia as a habitat-improvement strategy for snake conservation, *In* J. B. Murphy, K. Adler, and J. T. Collins (eds.), Captive Management and Conservation of Amphibians and Reptiles. Society for the Study of Amphibians and Reptiles, Ithaca (New York). Contributions to Herpetology, Vol. 11.

- Zappalorti, R. T. and J. Burger. 1985. On the Importance of Disturbed Sites to Habitat Selection by Pine Snakes in the Pine Barrens of New Jersey. *Environmental Conservation*, 12(4):358-361.
- Zappalorti, R. T. and H. K. Reinert. 1986. A Final Report on a Radio-tracking Study of the Timber Rattlesnake (*Crotalus horridus*) in Southern New Jersey, with special notes on hibernation. Unpublished report submitted to the NJDEP, HA File No. 85.13:1-175.
- Zappalorti, R. T. and H. K. Reinert. 1992. Distribution and habitat utilization of the timber rattlesnake (*Crotalus horridus* - Linnaeus), in southern New Jersey with notes on hibernation. T. F. Tynning, ed., *In Conservation of the Timber Rattlesnake in Northeast Massachusetts*. Massachusetts Audubon Society, Lincoln, Massachusetts. Pages 1-2.
- Zappalorti, R. T., and M. E. Torocco. 2002. A Standardized Protocol for Sampling Rare Snakes in the New Jersey Pine Barrens: Critical Habitat Assessment, Survey Techniques, and Trapping Methods. Unpublished report submitted on July 31, 2002, to Carleton Montgomery, Executive Director, The Pinelands Preservation Alliance, 114 Hanover Street, Pemberton, New Jersey 08068. Herpetological Associates, Inc. - Plant and Wildlife Consultants, 575 Toms River Road (Rt. 571), Jackson, New Jersey 08527.
- Zappalorti, R. T., E. W. Johnson, and Z. Leszczynski. 1983. The Ecology of the Northern Pine Snake (*Pituophis melanoleucus*), (Daudin - Reptilia, Serpentes, Colubridae), in Southern New Jersey, with special notes on habitat and nesting behavior. *Bulletin, Chicago Herpetological Society* 18:57-72.

